

INVESTIGATION OF SUPPORT REACTIONS OF A SIMPLY SUPPORTED BEAM

Dr. Ali Hasan*

Abstract

The aim of author is to find experimentally the Reactions of a simply supported beam. These reactions are compared by analytical values and percentage error is determined. Both the reactions obtained experimentally and analytically are plotted using Microsoft Excel software. The sources of error are recognized and tried to minimize them. The paper is beneficial for U.G./P.G.students ad /Research scholars working for their project and thesis work.

Keywords:

Reactions,
Equilibrium,
Engineering Mechanics.

*** Assistant Professor, Department of Mechanical Engineering, Faculty of Engineering & Technology, Jamia Millia Islamia, New Delhi- India,**

1. Introduction

Figure-1 shows various types of beams. The types of support and their reactions are shown in Figure-2. Table-1 shows the various supports and their resisting load. Thomas [1] developed a mechanism for vehicle raising and lowering. Razzaghi [2] gaved a screw jack that was operated by electrical power for lifting and lowering the automobile specially for changing typres. Patil et. al. [3] developed a device to minimize the human effort at the time of raising and lowering the vehicle. Tarachand [4] showed the mechanisms to optimize the efficiency by varying screw helix angle. Imani et al. [5] solved the problems related with stochastic control of gene regulatory networks. Imani M., et al. [6] developed a mechanism also based on Partially-observed Boolean dynamical systems. Ghoreishi et. al. [7] suggested a novel approach for uncertainty propagation to multidisciplinary system with feedback couplings. McClenny, et al. [8] showed that the Gene regulatory networks govern the function of key cellular processes. Imani, and Braga-Neto [9] developed a system for the simultaneous estimation of state and parameters of Partially Observed Boolean Dynamical Systems. The author directly or indirectly utilizes a number of references including [10-23] for this research work. A parallel beam apparatus has been shown in Figure-3. A FBD is drawn in Figure-4. Conditions of equilibrium $\Sigma F = 0$ and $\Sigma M = 0$ can be applied to determine the support reactions analytically. This experiment is based on 'Principle of equilibrium' which states that if a body is in equilibrium under the action of a number of coplanar forces then the algebraic sum of all the forces and their moments about any point in their plane are zero.

Mathematically: The beam will be in equilibrium, if

$\Sigma H = 0$ i.e. the algebraic sum of all horizontal forces is zero.

$\Sigma V = 0$ i.e. the algebraic sum of all Vertical forces is zero.

$\Sigma M = 0$ i.e. the algebraic sum of all moments about a point is zero.

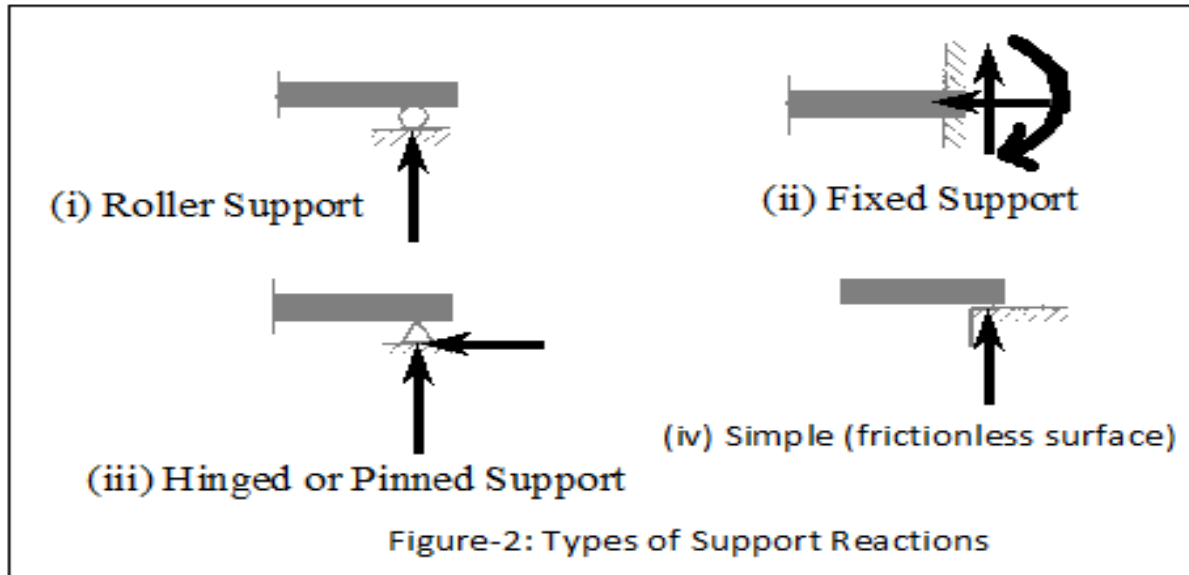
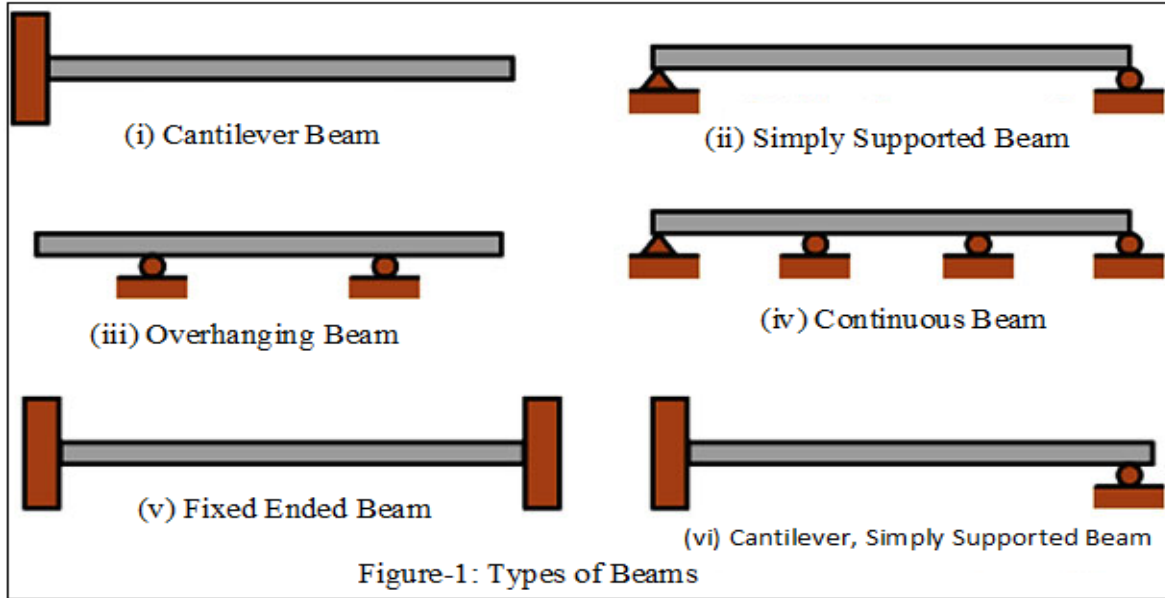





Table-1: Types of supports and Resisting Loads

S.N.	Types of Support	Representation by	Reaction Force	Resisting Load
1.	Roller Support		Vertical	Vertical loads
2.	Pinned Support		Horizontal and vertical	Vertical and horizontal loads
3.	Fixed Support		Horizontal, vertical and moments	All types of loads Horizontal, vertical and Moments
4.	Simple Support		Vertical	Vertical loads

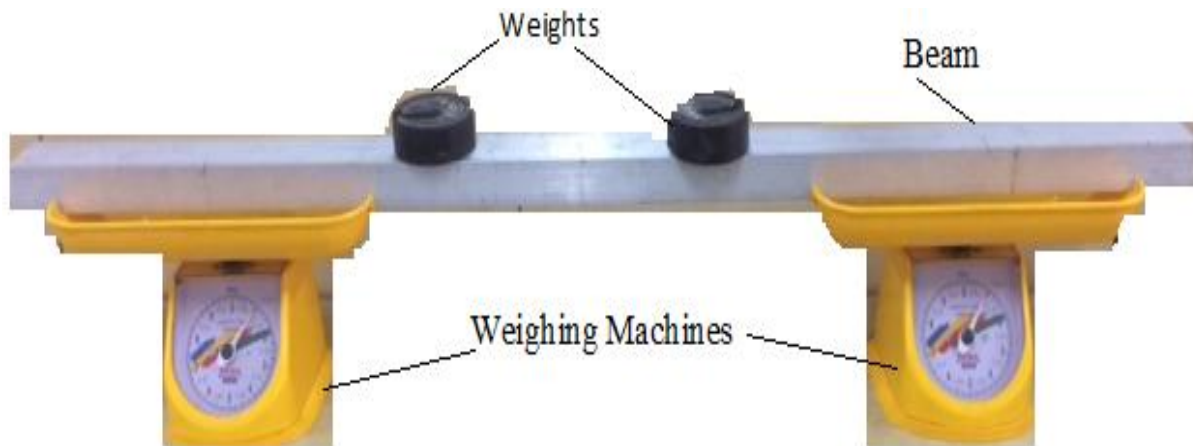

Figure-3: Parallel Beam Apparatus

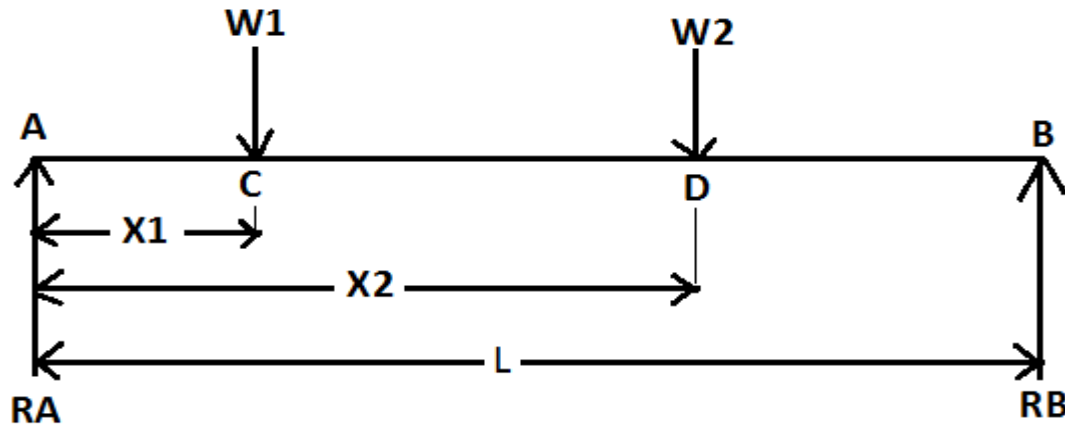

Figure-4: Free body diagram of Parallel Force Apparatus

2. Methodology

Step-1: Put the simply supported beam of length L . check and calibrate both the simple supports (Weighing machine). After placing the beam on supports, note down the reading of the reactions on the weighing machines.

Step-2: put the loads arbitrarily on the beam and note down the reading of the reactions on the weighing machines.

Step-3: now record the magnitude and positions of W_1 W_2 . Let their their distances are X_1 , X_2 from the left support 'A'.

Step-4: Record the left and right support weighing machine readings.

Step-5: the above said procedure is repeated changing either the magnitude of the weights or positions of the weights or both of them upto at least ten readings.

Step-6: Compare the experimental values of support reactions with analytical values obtained by applying Conditions of Equilibrium. If there is any difference between observed and calculated reactions then calculate the percentage error.

$$\Sigma F = 0,$$

$$R_A + R_B = W_1 + W_2$$

$$\Sigma M_A = 0$$

$$R_B \cdot L = W_1 \cdot X_1 + W_2 \cdot X_2$$

$$R_B' = R_B \text{ Manual} = \text{Calculated reaction force at B}$$

$$R_A' = R_A \text{ Manual} = \text{Calculated reaction force at A}$$

$R_B = R_B \text{ EXP} =$ Observed reaction force (from weighing machine) at support B

$R_A = R_A \text{ EXP} =$ Observed reaction force (from weighing machine) at support A

Percentage error at point A = $(R_A \text{ EXP} - R_A \text{ Manual} / R_A \text{ EXP}) * 100$

Percentage error at point B = $(R_B \text{ EXP} - R_B \text{ Manual} / R_B \text{ EXP}) * 100$

3. Observations

Table-2: Observation of Simply Supported Beam Reactions, L = 84 cm

S.N	Readings from		Weight		Distance of Loads		Sum of Moments (gm-cm)	Calculated Reactions (kg)		%age Error = $(R \text{ EXP} - R \text{ Manual} / R \text{ EXP}) * 100$		Length of Beam L (cm)
	RA Exp	RB Exp	W1	W2	X1	X2		RA Manual	RB Manual	at end A	at end B	
	1	900	900	900	900	0	84	75600	900.0	900.0	0.0	0.0
2	850	950	1800	0	42	42	75600	900.0	900.0	-5.9	5.3	84
3	1450	1250	1900	900	30	54	105600	1542.9	1257.1	-6.4	-0.6	84
4	1700	1100	1900	900	18	60	88200	1750.0	1050.0	-2.9	4.5	84
5	950	1100	1000	1000	30	60	90000	928.6	1071.4	2.3	2.6	84
6	1000	1100	1100	1000	40	50	94000	981.0	1119.0	1.9	-1.7	84
7	1550	900	1200	1200	20	40	72000	1542.9	857.1	0.5	4.8	84
8	1350	1200	1500	1000	35	45	97500	1339.3	1160.7	0.8	3.3	84
9	1400	1600	1500	1500	42	50	138000	1357.1	1642.9	3.1	-2.7	84
10	1250	2300	2000	1500	50	60	190000	1238.1	2261.9	1.0	1.7	84

Table-3: Comparison of Results between Theoretical and Experiment Reactions

S.N	W1	W2	RA Exp	RA Manual	RB Exp	RB Manual	L (cm)
1	900	900	900	900.0	900	900.0	84
2	1800	0	850	900.0	950	900.0	84
3	1900	900	1450	1542.9	1250	1257.1	84
4	1900	900	1700	1750.0	1100	1050.0	84
5	1000	1000	950	928.6	1100	1071.4	84
6	1100	1000	1000	981.0	1100	1119.0	84
7	1200	1200	1550	1542.9	900	857.1	84
8	1500	1000	1350	1339.3	1200	1160.7	84
9	1500	1500	1400	1357.1	1600	1642.9	84
10	2000	1500	1250	1238.1	2300	2261.9	84

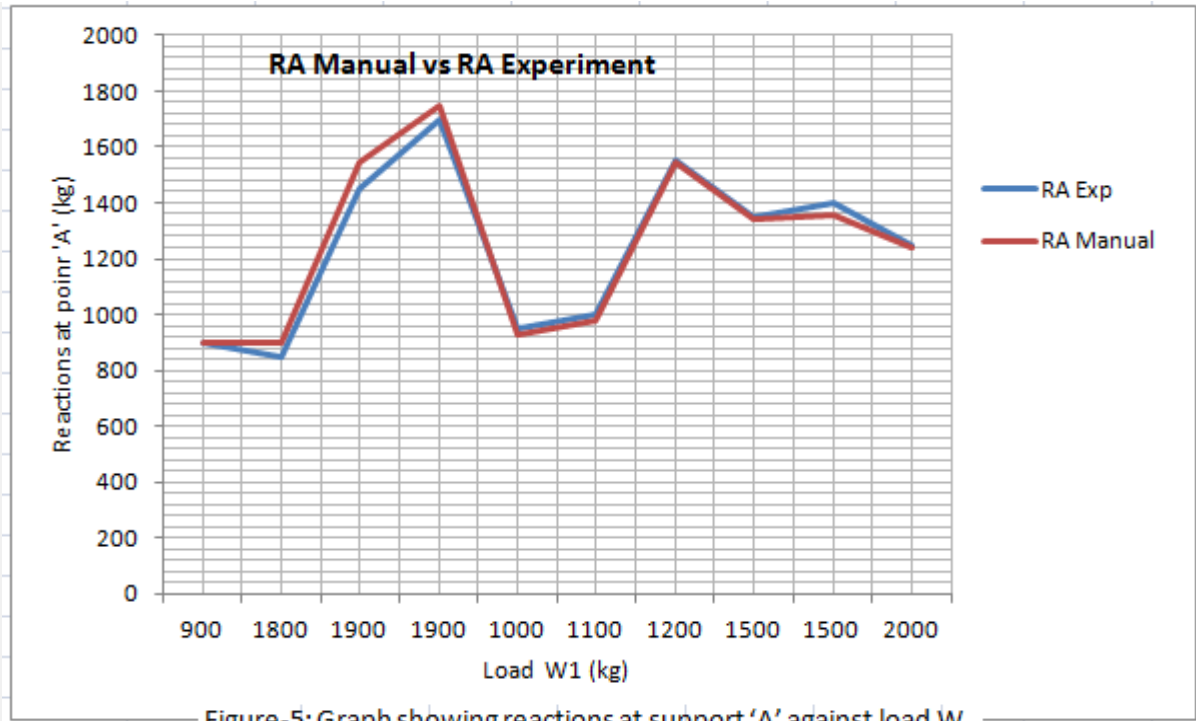

Figure-5: Graph showing reactions at support 'A' against load W_1

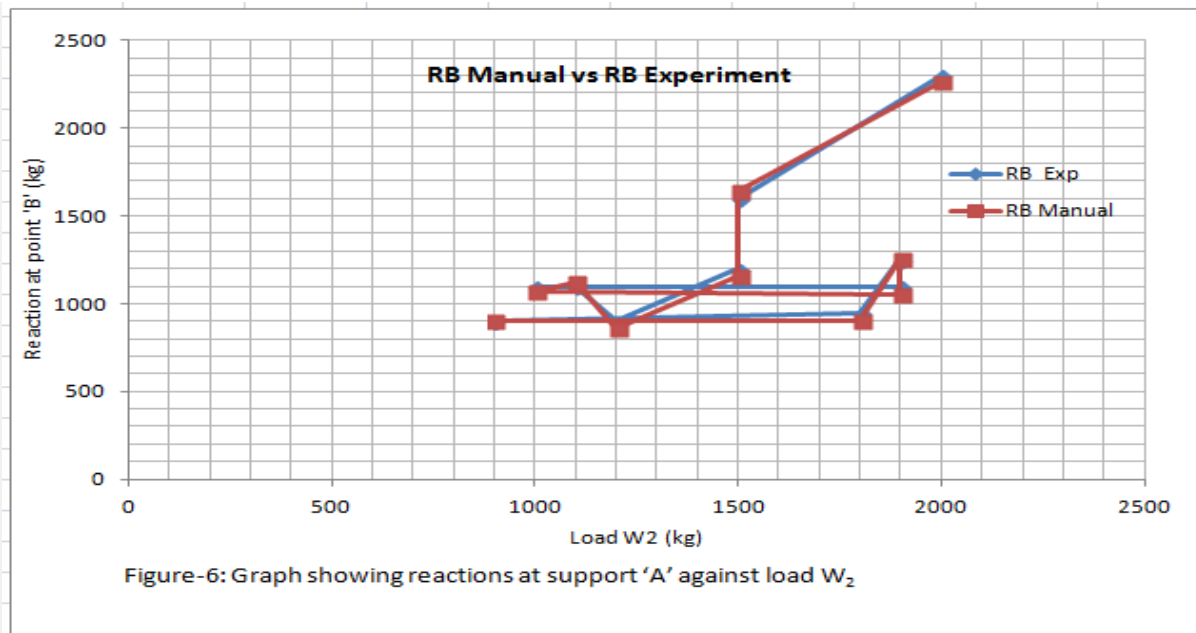

Figure-6: Graph showing reactions at support 'A' against load W_2

4. Result

The average %age error between experimental and manual reactions is 2.8% at end 'A' and 2.72% at end 'B'. Detailed analysis of the results is listed in Table-2 and table-3. The same analysis has been shown graphically in Figure-5 and Figure-6.

5. Conclusion

According to Figure-5 (RA Manual vs. RA Experiment against Load W1) and Figure-6 (RB Manual vs RB Experiment against Load W2) which show the manual and experimental reaction at the end point 'A' against the Load W and Point B against load W2. We observe that at the beginning, the manual result is slightly higher than the experimental results. Both the values are shown by different colors of line. The blue line represent the experimental while the red line for manual results. In both the Figure-5 and Figure-6, we see that all most, both the lines are moving parallel to each other except at some points. Where both the lines are not parallel to each other, there is some sort of experimental/ human error taking place at these points. Both the lines (experimental and manual) are parallel to each other means that the experiment performed successfully within the possible permissible errors. If the beam is thinner the results may not be accurate because the stiffness of thinner beam is lesser than a thicker one. Further, experimental errors may be eliminated by following more care in taking the readings.

Acknowledgments

The author appreciates and is thankful to Head, Department of Mechanical Engineering, F/O-Engineering and Technology, Jamia Millia Islamia (A Central University), New Delhi for granting permission and all those who participated in the study and helped me to facilitate the research process successfully.

References

- [1] Thomas J. Prather, "Vehicle lift system" United States Patent Issued on January 6, 2009, Patent Number: US 7472889 B1.
- [2] Farhad Razzaghi, US. "Apparatus and method for an electric jack" United States Patent Issued on November 8, 2007, Patent Number: US 2007/0256526 A1.
- [3] Manoj Patil, Gaurav Udgirkar, Rajesh Patil and Nilesh, "Automated Car Jack", International Journal of Current Engineering and Technology ,Vol.4, No.4, Aug 2014.
- [4] Lokhande Tarachand G., Chatpalliwar Ashwin S. And Bhoyar Amar A., "Optimizing Efficiency of Square Threaded Mechanical Screw Jack by Varying Helix Angle", International Journal of Modern Engineering Research (IJMER), Vol.2, Issue.1, pp504-508, Jan-Feb 2012.

- [5] Imani Mahdi and Ulisses M. Braga-Neto, " Control of Gene Regulatory Networks with Noisy Measurements and Uncertain Inputs," IEEE Transactions on Control Systems Technology, 2018. (DOI: 10.1109/TCST.2017.2789191).
- [6] Imani M., et al. "Particle filters for partially-observed Boolean dynamical systems". Automatica 87 (2018): 238-250.
- [7] Ghoreishi S. F. and Allaire D. L. "Adaptive Uncertainty Propagation for Coupled Multidisciplinary Systems", AIAA Journal, Vol. 55, No. 11 (2017), pp. 3940-3950. <https://doi.org/10.2514/1.J055893>
- [8] McClenny L.D, Imani M. and Braga-Neto UM, "BoolFilter: an R package for estimation and identification of partiallyobserved Boolean dynamical systems" BMC bioinformatics 18.1 (2017): 519. doi: 10.1186/s12859-017-1886-3.
- [9] Imani M., and Braga-Neto U.M., "Maximum-Likelihood Adaptive Filtering for Partially-Observed Boolean Dynamical Systems," IEEE Transactions on Signal Processing 65.2 (2017): 359-371.
- [10] I. H. Shames, "Engineering Mechanics: Statics and dynamics", 4th Editions, PHI, 2002.
- [11] F. P. Beer & E. R. Johnston, "Vector Mechanics for Engineers, Vol I - Statics, Vol II – Dynamics", 10th Editions, Tata McGraw Hill, 2013.
- [12] J. L. Meriam & L. G. Kraige, "Engineering Mechanics, Vol I – Statics, Vol II – Dynamics", 7th Ed, Wiley India Pvt Ltd, 2013.
- [13] R. C. Hibbler, "Engineering Mechanics: Principles of Statics and Dynamics", 11th editions, Pearson Press, 2009.
- [14] Andy Ruina & Rudra Pratap, "Introduction to Statics and Dynamics", Oxford University Press, 2011.
- [15] H.J. Sawant, "Engineering Mechanics", 2nd Edition, Technical Publication, 2013.
- [16] Boresi & Schmidt, "Engineering Mechanics-Statics & Dynamics", First edition, Cengage Learning India Pvt Ltd, 2008.
- [17] S. Thimoshenko & D.H. Young, "Engineering Mechanics", 5th edition, Tata McGraw Hill, 2013.
- [18] A. Nelason , "Engineering Mechanics: Statics and Dynamics", McGraw-Hill Edition, 2009.
- [19] K. L. Kumar and V. Kumar, "Engineering Mechanics", 4th Editions, McGraw Hill, 2010.
- [20] B. Bhattacharya, "Engineering Mechanics", First Edition, Oxford Press Publications, 2008.

[21] Hestenes, D., Wells, M., & Swackhamer, G. (1992). Force concept inventory. *The Physics Teacher*, 30 (3), 141- 153

[22] Peter N. Oliver ,*Pierre Varignon* and the Parallelogram Theorem, *MATHEMATICS TEACHER*, Vol. 94, No. 4 • April 2001,pp.316-319.

[23] Carmen MARTÍNEZ ADAME, The parallelogram law in the works of d'Alembert and Kant, *THEORIA* 75 (2012): 365-388.