

POWER QUALITY IMPROVEMENT USING PWM VOLTAGE REGULATOR

S. Gupta*

ABSTRACT:

In this present paper, stress has been laid upon the present scenario of power quality in every grid. With more and more use of non linear electrical loads instead of linear loads, we get increased efficiency with reduced power requirements; however this degrades the power quality of whole power system. Power quality is basically determined by the voltage magnitude and frequency in a system. To improve it, we can use voltage regulators, filters, etc.

In this paper use of voltage regulator using PIC16F877A microcontroller has been presented, which works on concept of PWM voltage regulator and can be called as a smart circuit. It provides good automated regulation without consuming much power. Only major drawback is the presence of harmonics in the output, thus improvement in the circuit is required from this point of view.

Keywords: Power quality, non linear electrical loads, voltage regulator, smart circuit, automated regulation.

* Asso. Prof, NIT Raipur.

I. INTRODUCTION:

Power quality is the set of limits of electrical properties that allows electrical systems to function in their intended manner without significant loss of performance or life. The term is used to describe electric power that drives an electrical load and the load's ability to function properly with that electric power. Without the proper power, an electrical device (or load) may malfunction, fail prematurely or not operate at all. While "power quality" is a convenient term for many, it is the quality of the voltage - rather than power or electric current - that is actually described by the term. Power is simply the flow of energy and the current demanded by a load is largely uncontrollable.

The quality of electrical power may be described as a set of values of parameters, such as:

- Continuity of service
- Variation in voltage magnitude
- Transient voltages and currents
- Harmonic content in the waveforms etc.

Power quality is the measurement of how close to perfect an electrical voltage is, at any given time or point. High quality electrical voltage is a sine wave that measures exactly what is expected in both voltage and frequency.[1]

Historically, most power quality problems were considered to be those things that affected the distribution of power. Lightning line or transformer failures and/or very high electrical demands (brown outs) on electrical network are just a few. Today, however, most power quality problems are due to technology changes and the way electricity is used.

II. LINEAR AND NON-LINEAR LOADS:

Linear Loads: AC electrical loads where the voltage and current waveforms are sinusoidal. The current at any time is proportional to voltage. Linear loads are: incandescent lamps, heaters, power factor improvement capacitors, etc.

Non-Linear Loads: Applies to those ac loads where the current is not proportional to the voltage. Foremost among loads meeting their definition is gas discharge lighting having saturated ballast coils and thyristor (SCR) controlled loads. The nature of non-linear loads is to generate harmonics in current waveform. This distortion of current waveform leads to distortion of voltage waveforms. Under these conditions, the voltage waveform is no longer proportional to current. Non linear loads are: Computer, Laser Printers, SMPS, Rectifier, PLC, Electronic Ballast, Refrigerator, TV, etc.

In the past, most electrical loads were linear. This is what made “brownouts” (drop in voltage in an electrical power supply) attractive to utilities. If the power company reduced the voltage, the current would reduce as would the total they demand.

This brings about nonlinear loads which draw current independent of utility voltage but depends on power required. One such commonly used load was static UPS, used to provide regulated output voltage to the critical load. If utility voltage decreases, UPS compensates for it by drawing more current (constant kW operation).

One of the major advances in power supply design is the switch mode power supply (SMPS). These new devices cost less and use less power, however cause major problems with power quality.

A power supply has to convert the alternating current (AC) furnished by utility to direct current (DC) used by the system in which it is installed. Initially, power supplies were linear type. They have four major sections. The first section is transformer, which will step down the supply voltage to a lower voltage. The transformed voltage is then fed to rectifier (Diode Bridge) to convert AC to DC. As DC voltage still has AC ripples, the rectified voltage is then filtered to make it usable by the logic. The capacitor performs the function of smoothening the rectified utility voltage to logic grade DC voltage. The final section here is the voltage regulator that compensates for varying supply voltages from utility.

The linear supply produced heat and was slow responding to voltage changes. The transformer and voltage regulator both generate heat that could damage the computer’s logic if room was not kept cool.

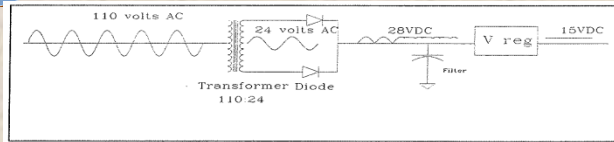

Fig.1: Linear Power Supply

Advances in voltage regulators and power switching devices lead to major improvements in field of power supply. The transformers were removed and voltage regulator was combined with rectifiers. The operation was based on principles that power and not voltage could be regulated. The new switch mode power supplies operate by opening a valve (switch) and letting pulses of current enter power supply. The switch will turn on several thousand times each second, which greatly improved the ability to respond to changing input voltages.

The figure below shows a typical output from switch mode power supply.

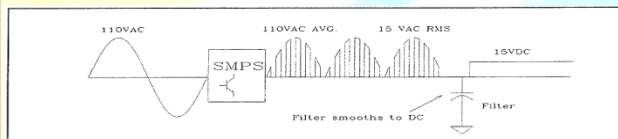

Fig. 2: Non-Linear Power Supply

SMPS solved many problems that computers suffered with linear supplies. But some new problem was identified that was power quality deterioration. The power taken from electrical source is not drawn evenly. The pulses occur many times each cycle, at a higher frequency than electrical generators used by power companies. The effect of high frequency power supplies is to strain the electrical system. Transformers, circuit breakers and other electrical devices are designed to operate at a specific frequency. Thus apart from unexpected operation, high frequencies lead to heating of equipments. In data centers, some of the most common problems have been neutral conductors failing, unexplained opening of circuit breakers and transformer failures. Transformers are running at their design limit.

The pulse currents cause one more problem other than high frequency issue. When a switching power supply takes pulses of current and several power supplies all turn on at the same time, peak currents can be very large while average current can be seen by standard metering as within the capability of power system. The term that

defines the peak current (power) is a crest factor.

Fig. 3: Crest Factor

Fig. 3 shows two waveforms. The first is a normal current that the most power systems expect, and second is a pulse that is shorter in time but higher in peak. Both waveforms have same amount of power but one stresses the electrical system more than other.

III. POWER QUALITY PROBLEMS:

Include all possible situations in which the waveforms of the supply voltage or load current deviate from the sinusoidal waveform at rated frequency with amplitude corresponding to the rated rms value for all three phases of a three-phase system.

Power quality disturbance covers sudden, short duration deviation impulsive and oscillatory transients, voltage dips (or sags), short interruptions, as well as steady- state deviations, such as harmonics and flicker.

Some of the power quality problems are:

- Voltage Sag
- Voltage Swell
- Voltage Interruption
- Under/ Over Voltage
- Voltage Flicker
- Harmonic Distortion
- Voltage Notching
- Transient Disturbance
- Outage and frequency variation

Voltage Sag

Voltage sag is a reduction in the RMS voltage in the range of 0.1 to 0.9 p.u. (retained) for duration greater than a mains cycle and less than 1 minute. It is often referred to as a 'dip'. It is caused by faults, increased load demand and transitional events such as large motor starting.

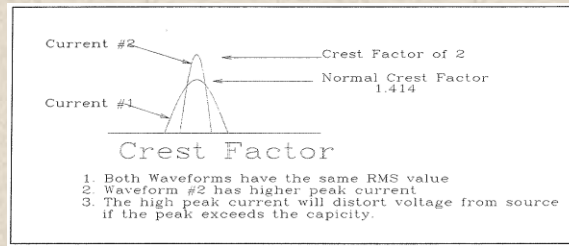

- **Voltage Swell**

A voltage swell is an increase in the RMS voltage in the range of 1.1 to 1.8 p.u. for a duration greater than half a main cycle and less than 1 minute. It is caused by system faults, load switching and capacitor switching.

- **Voltage Interruption**

A *voltage interruption* is the complete loss of electric voltage. Interruptions can be short duration (lasting less than 2 minutes) or long duration. A disconnection of electricity causes an interruption—usually by the opening of a circuit breaker, line re-closure, or fuse.

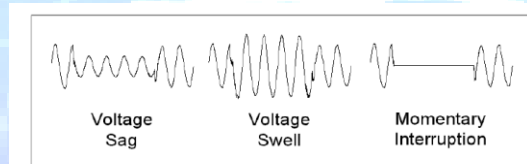

Fig. 4: Voltage Sag, Swell and Interruption

- **Over Voltage and Under Voltage**

Long-duration voltage variations that are outside the normal limits (that is, too high or too low) are most often caused by unusual conditions on the power system. For example, out-of-service lines or transformers sometimes cause *under voltage* conditions. These types of root-mean-square (RMS) voltage variations are normally short term, lasting less than one or two days. In addition, voltage can be reduced intentionally in response to a shortage of electric supply.

- **Voltage Flicker**

A waveform may exhibit *voltage flicker* if its waveform amplitude is modulated at frequencies less than 25 Hz, which the human eye can detect as a variation in the lamp intensity of a standard bulb. Voltage flicker is caused by an arcing condition on the power system.

Flicker problems can be corrected with the installation of filters, static VAR systems, or distribution static compensators.

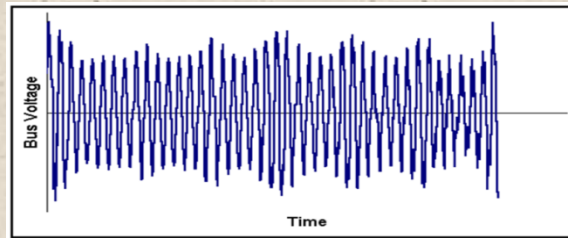

Fig. 5: Voltage Flicker

- **Harmonics**

A pure sinusoidal voltage is conceptual quantity produced by an ideal AC generator build with finely distributed stator and field windings that operate in a uniform magnetic field. Since neither the winding distribution nor the magnetic field is uniform in a working AC machine, voltage waveform distortion is created, and the voltage time relation-ship deviates from the pure sine function. The distortion at the point of generation is very small (about 1% to 2%), but nonetheless it exists.

Because this is a deviation from a pure sine wave, the deviation is in the form of a periodic function and by definition, the voltage distortion contains harmonics. When a sinusoidal voltage is applied to a certain type of load, the current drawn by the load is proportional to the voltage and impedance and follows the envelope of the voltage wave form. These loads are referred to as linear loads (loads where the voltage and current follow one another without any distortion to their pure sine waves) such as resistive heaters, incandescent lamps and constant speed induction and synchronous motors. In contrast some loads cause the current to vary disproportionately with the voltage during each half cycle. These loads are classified as nonlinear loads and the current and voltage have waveforms that are non sinusoidal containing distortions where by 50 Hz waveform has numerous additional waveforms superimposed upon it creating multiple frequencies within the normal 50 Hz sine wave. The multiple frequencies are harmonics of the fundamental frequency.

Power systems designed to function at the fundamental frequency which is 50 Hz in India are prone to unsatisfactory operation and at times failure when subjected to voltages and currents that contains substantial harmonic frequency elements. Very often the operation of electrical

equipment may seem normal but under a certain combination of conditions the impact of harmonics is enhanced with damaging results.

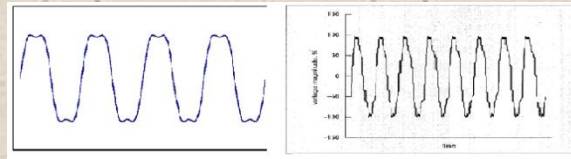

Fig.6: Distorted Voltage Waveforms

- **Voltage Notching**

Voltage notching is caused by the commutation of power electronic rectifiers. It is an effect that can raise PQ issues in any facility where solid-state rectifiers (for example, variable-speed drives) are used [2,3].

When the drive DC link current is commutated from one rectifier thyristor to the next, an instant exists during which a line-to-line short circuit occurs at the input terminals to the rectifier.

With this disturbance, any given phase voltage waveform will typically contain four notches per cycle as caused by a six-pulse electronic rectifier.

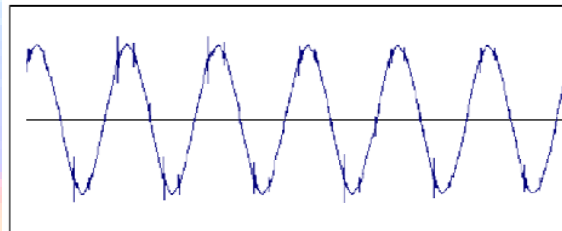

Fig. 7: Voltage Notching Waveform

- **Transient Disturbance**

Transient disturbances are undesirable momentary deviation of the supply voltage or load current and caused by the injection of energy by switching or by lightning.

Transients are classified in two categories “Impulsive” and “oscillatory”.

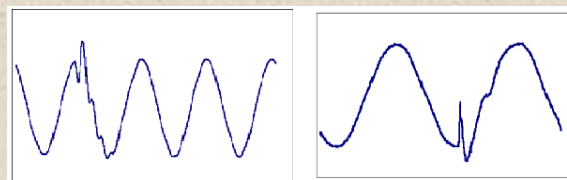

Fig. 8: Oscillatory transient waveform

Fig.9: Impulsive transient waveform

- **Outage**

Outage is defined as an interruption that has duration lasting in excess of one minute

- **Frequency Deviation**

It is a variation in frequency from the nominal supply frequency above/below a predetermined level, normally $\pm 0.1\%$.

Solution of Power Quality Problems

Flicker Mitigation [4]

- Static Var Compensator
- D-STATCOM

Harmonic Mitigation [5]

- Passive Filter
- Active Filter
- Multi-pulse Configuration

Mitigation of Voltage Dips and Short Interruption

- Motor-generator set
- Static series compensator
- Dynamic voltage restorer (DVR)
- Static transfer switch

Other Possible Solutions

- Proper earthing practices
- Online UPS/Hybrid UPS
- Energy storage system

- Ferro- resonant transformer
- Network equipment and design

Voltage Regulator

A voltage regulator generates a fixed output voltage of a preset magnitude that remains constant regardless of changes to its input voltage or load conditions. There are two types of voltage regulators: **linear and switching**.

A linear regulator employs an active (BJT or MOSFET) pass device (series or shunt) controlled by a high gain differential amplifier. It compares the output voltage with a precise reference voltage and adjusts the pass device to maintain a constant output voltage [6].

A switching regulator converts the dc input voltage to a switched voltage applied to a power MOSFET or BJT switch. The filtered power switch output voltage is fed back to a circuit that controls the power switch on and off times so that the output voltage remains constant regardless of input voltage or load current changes.

Switching regulator has three common topologies: buck (step-down), boost (step-up) and buck-boost(step-up/step-down). Other topologies include the flyback, SEPIC, Cuk, push-pull, forward, full-bridge, and half-bridge topologies.

Switching regulators require a means to vary their output voltage in response to input and output voltage changes. One approach is to use PWM that controls the input to the associated power switch, which controls its on and off time (duty cycle). In operation, the regulator's filtered output voltage is fed back to the PWM controller to control the duty cycle. If the filtered output tends to change, the feedback applied to the PWM controller varies the duty cycle to maintain a constant output voltage.

Voltage Stabilizer Using PIC16F877A

Voltage stabilizers are used for many appliances in home, offices and industries. The mains supply suffers from large voltage drops due to losses on the distribution lines. A voltage stabilizer maintains the voltage to the appliances at the nominal value of around 220volts even if the inputs main fluctuates over a wide range.

The circuit of an automatic voltage stabilizer can be adapted to any power rating. Its intelligence lays in the program on PIC16F877A-a low cost microcontroller that is readily available. The circuit, when used with any appliances, will maintain the voltage at around 220V even if the input mains voltage varies between 180V and 250V [7].

Here the circuit is shown for a 5A stabilizer. It acts within 100ms to produce a smoothly varying output whenever inputs mains voltages.(Servo stabilizers move a variable contact on a toroidal auto transformer to adjust the output when input goes up and down, which take seconds.)

The PIC16F877A is an RISC (Reduced Instruction Set Computer) microcontroller with 35 instructions, and hence program development with it is rather tough. But there are good support programs.

The circuit is divided into two sections:

- i) Voltage stabilizer controller section: (Fig.10) and
- ii) Voltage stabilizers buck –boost: (Fig.11)

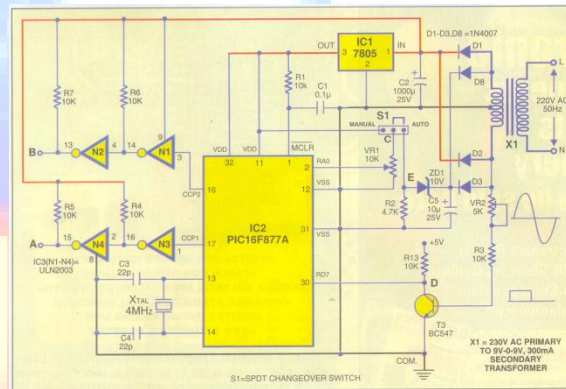

Fig. 10: Voltage Stabilizer Controller Section

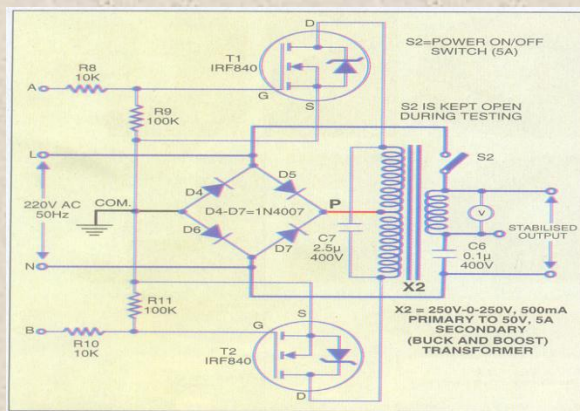

Fig.11: Voltage Stabilizer Buck-Boost Section

Voltage stabilizers buck (subtract) the mains voltage if it is higher than 220V and boost (add) the mains voltage if it is lower than 220V. For this purpose, we need to produce a small voltage to do addition or subtraction (Fig. 12).

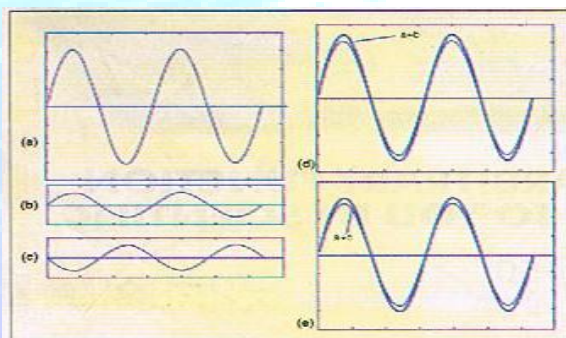

Fig. 12:

(a) AC mains, (b) Small additive voltage of 30V in phase with 'a', (c) Small subtractive voltage of 30V out of phase with 'a', (d) Voltage waveform 'a+b', (e) Voltage waveform 'a-c'

PWM Concept

The microcontroller produces pulse-width, as required, for generating the voltage to be added or subtracted from points A and B and fed to the transformer as shown in Fig.10. The secondary voltage winding of this transformer gives the adding voltage. In this case, there is no relay switching; the buck or boost is done smoothly by changing the phase of the adding signal instantly. So it is a continuous voltage stabilizer. Depending on how much the input varies from

220V, pulse width is generated so as to adjust the output voltage by adding or subtracting from it. This is a feed-forward control.

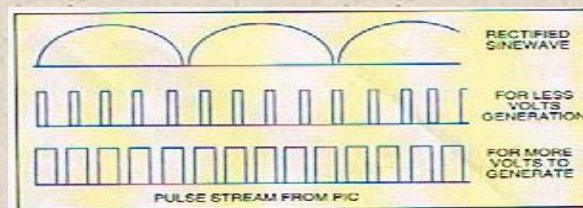

Fig. 13: PWM concept- Variation of pulse according to voltage variation.

Microcontroller PIC16F877A

A microcontroller is a small computer on a single integrated circuit containing a processor core, memory, and programmable input/output peripherals. Program memory in the form of NOR flash or OTP ROM is also often included on chip, as well as a typically small amount of RAM. Microcontrollers are designed for embedded applications, in contrast to the microprocessors used in personal computers or other general purpose applications.

By reducing the size and cost compared to a design that uses a separate microprocessor, memory, and input/output devices, microcontrollers make it economical to digitally control even more devices and processes. Mixed signal microcontrollers are common, integrating analog components needed to control non-digital electronic systems.

Some microcontrollers may use four-bit words and operate at clock rate frequencies as low as 4 kHz, for low power consumption (mill watts or microwatts). They will generally have the ability to retain functionality while waiting for an event such as a button press or other interrupt; power consumption while sleeping (CPU clock and most peripherals off) may be just nanowatts, making many of them well suited for long lasting battery applications. Other microcontrollers may serve performance-critical roles, where they may need to act more like a digital signal processor (DSP), with higher clock speeds and power consumption.

PIC16F877A Device Features

Key Features	PIC16F877A
Operating Frequency	DC – 20 MHz
Resets (and Delays)	POR, BOR (PWRT, OST)
Flash Program Memory (14-bit words)	8K
Data Memory (bytes)	368
EEPROM Data Memory (bytes)	256
Interrupts	15
I/O Ports	Ports A, B, C, D, E
Timers	3
Capture/Compare/ PWM modules	2
Serial Communications	MSSP, USART
Parallel Communications	PSP
10-bit Analog-to Digital Converter	8 input channels
Analog Comparators	2
Instruction Set	35 Instructions
Packages	40-pin PDIP, 44-pin PLCC 44-pin TQFP, 44-pin QFN

Pin Diagram of PIC16F877A 40 Pin PDIP

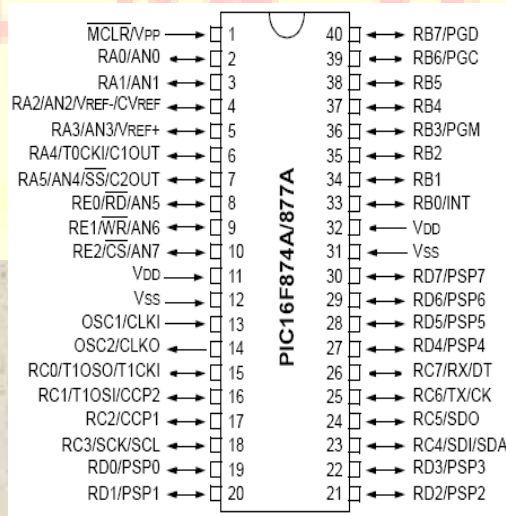

Fig. 14: Pin Diagram

Result and Conclusion:

Output Waveform of Voltage Regulator

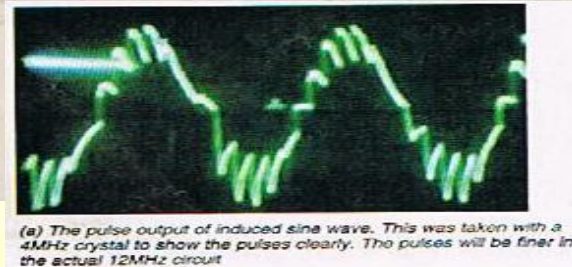

Fig. 15 Output Voltage Waveform

Result In Terms of Voltage Regulation

The Voltage Regulator using PIC16F877A microcontroller is smart voltage regulator good for domestic appliances. Theoretically, it can give an output voltage of 220V in the range of voltage variation of 180V to 250V mains. However it is accompanied by some harmonic content as seen from the waveform.

When the fabricated circuit was tested in lab, it gave an output voltage of 198V for an input of 180V mains. Thus it can be said to provide a **voltage regulation of 9.09%**.

Conclusion:

Voltage regulator using microcontroller PIC16F877A is a good, efficient technique to regulate voltage because it makes use of intelligence of microcontroller for its functioning. Also it is completely automated voltage regulator circuit with least user intervention for its functioning. However the output contains lot of harmonics (mainly 5th harmonics) that makes use of a harmonic filter, in series of circuit, quite necessary. If current capacity of various equipments used in circuit is increased it may be used for industrial purpose.

References:

- John Stones and Alan Collinson “Introduction to Power Quality”, Power Engineering Journal 2001.
- Ray Arnold “Solutions to Power Quality Problems”, Power Engineering Journal 2001.
- A. de Almeida, L. Moreira. J. Delgado “Power Quality Problems and New Solutions”, ICREPQ'03 Vigo, April, 2003.
- H. Hingorani “Introducing custom power” IEEE spectrum, vol.32 no.6 June 1995
- M. Bollen, “Understanding Power Quality– Voltage Sags and Interruptions”, IEEE Press Series on Power Engineering – John Wiley and Sons, Piscataway, USA (2000)
- P. Ferracci, “ Power Quality”, Schneider Electric Cahier Technique no. 199, September 2000
- Prof. K. Pdmanabhan “Voltage Stabiliser using PIC16F877A”, Electronics For You, August 2010
- Nebojsa Matic “PIC Microcontrollers, for beginners too!”