

**COMPARATIVE STUDIES ON PERFORMANCE AND EMISSIONS OF FOUR STROKE COPPER COATED SPARK IGNITION ENGINE WITH CATALYTIC CONVERTER WITH DIFFERENT CATALYSTS WITH ALCOHOL BLENDED GASOLINE**

**Ch. Indira Priyadarsini\***

**M.V.S. Murali Krishna\***

**Y. Nagini\***

**P. Ushasri\*\***

**P.V.K.Murthy\*\*\***

**K.Kishor\***

**ABSTRACT**

**Aim:** Investigations were carried out to evaluate the performance of variable speed, variable compression ratio, four- stroke, single cylinder, spark ignition (SI)engine having copper coated engine [CCE, copper-(thickness, 300  $\mu$ ) coated on piston crown and inner side of cylinder head] provided with catalytic converter with sponge iron as catalyst with different test fuels of pure gasoline, gasohol (80% gasoline and 20% ethanol by volume) and methanol blended gasoline (80% gasoline and 20% methanol by volume) and compared with conventional engine (CE) with pure gasoline operation.

\* Mechanical Engineering Department, Chaitanya Bharathi Institute of Technology, Gandipet, Hyderabad- 500 075, India.

\*\* Mechanical Engineering Department, College of Engineering, Osmania University, Hyderabad- 500 007.

\*\*\* Jayaprakash Narayan Educational Society Group of Institutions, Mahabubnagar-509 001, India

**Study Design:** Performance parameters of speed, compression ratio, brake thermal efficiency (BTE), exhaust gas temperature (EGT) were varied with different values of brake mean effective pressure (BMEP).

**Methodology:** The exhaust emissions of carbon monoxide (CO) and un-burnt hydro carbons (UBHC) were measured with different values of BMEP. The engine was provided with catalytic converter with sponge iron and manganese ore as catalysts. There was provision for injection of air into the catalytic converter. The performance of the catalyst was compared with one over the other.

**Brief Results:** Brake thermal efficiency increased with gasohol with both versions of the engine. CCE showed improvement in the performance when compared with CE with both test fuels. Brake thermal efficiency increased with compression ratio and marginally with speed of the engine. Methanol blended gasoline decreased exhaust emissions effectively in comparison with gasohol with both versions of the engine. Catalytic converter with air injection significantly reduced pollutants with different test fuels on both configurations of the engine.

**Keywords:** SI engine, Gasohol, Methanol blended gasoline, CE, CCE, Fuel Performance, Exhaust emissions and Catalytic converter

## 1. INTRODUCTION

The civilization of a particular country depends on number of automotive vehicles being used by the public of the country. In view of heavy consumption of gasoline fuel due to individual transport and also fast depletion of fossil fuels, the search for alternate fuels has become pertinent apart from effective fuel utilization which has been the concern of the engine manufacturers, users and researchers involved in combustion & alternate fuel research. Alcohols are probable candidates as alternate fuels for SI engines, as their properties are compatible close to gasoline fuels. That too their octane ratings are very high. If alcohols are blended in small quantities with gasoline fuels, no engine modification is necessary.

Carbon monoxide (CO) and un-burnt hydrocarbons (UBHC), major exhaust pollutants formed due to incomplete combustion of fuel, cause many human health disorders [1-6]. Inhaling of these pollutants cause severe headache, vomiting sensation, loss of hemoglobin in the blood,

respiratory problems etc.,. Such pollutants also cause detrimental effects [6] on animal and plant life, besides environmental disorders. If the engine is run with alcohol, aldehydes are also to be checked. These aldehydes are carcinogenic in nature. The amount of exhaust emissions from the engine depends [3] on driving engine condition, driving methodology, road layout, traffic density, etc.,. Hence control of these emissions is immediate and an urgent task. There are many methods to improve the performance of the engine out of which engine modification [7-11] with copper coating on piston crown and inner side of cylinder head improves engine performance as copper is a good conductor of heat and combustion is improved with copper coating. Out of many methods available to control pollutants from SI engine, catalytic converter is effective [12-19] in reduction of pollutants in SI engine. The reduction of CO and UBHC depends on mass of the catalyst, void ratio (defined as ratio of the volume of the catalyst to the volume of catalytic chamber), temperature of the catalyst, air flow rate, speed and compression ratio of the engine, Engine performance improved [20-25] with change in fuel composition also. It was further improved [26-27] with simultaneous change of fuel composition and engine modification. Alcohols are blended with gasoline and used in copper coated engine so as to improve the performance of the engine. However, no systematic investigations were reported with the use of alcohols in copper coated engine with varied engine parameters.

The present paper reported the performance evaluation of CCE, with different test fuels of pure gasoline, gasohol (gasoline 80% and ethanol 20% by volume) and methanol blended gasoline (gasoline 80% and methanol 20% by volume) with varied speed, compression ratio and compared with CE with pure gasoline operation. The exhaust emissions of carbon monoxide (CO), un-burnt hydro carbons (UBHC) and aldehydes were controlled by catalytic converter with different catalysts of sponge iron and manganese ore and the performance of the catalyst was compared with one over the other.

## 1. METHODOLOGY

Figure 1 shows experimental set-up used for investigations on CCE with alcohol blended gasoline. A four- stroke, single-cylinder, water-cooled, SI engine (brake power 2.2 kW, at the speed 3000 rpm) was coupled to an eddy current dynamometer for measuring its brake power. Compression ratio of engine was varied (3-9) with change of clearance volume by adjustment of cylinder head, threaded to cylinder of the engine. Engine speeds were varied from 2000 to 3000 rpm. Exhaust gas temperature was measured with iron- constantan thermocouples. Fuel

consumption of engine was measured with burette method, while air consumption was measured with an air-box method. In catalytic coated engine, piston crown and inner surface of cylinder head were coated with copper by plasma spraying. A bond coating of Ni-Co-Cr alloy was applied (thickness, 100  $\mu$ ) using a 80 kW METCO (Company trade name) plasma spray gun. Over bond coating, copper (89.5%), aluminium (9.5%) and iron (1.0%) were coated (thickness 300  $\mu$ ). The coating has very high bond strength and does not wear off even after 50 h of operation [7]. Performance parameters of brake thermal efficiency (BTE), exhaust gas temperature (EGT) and volumetric efficiency (VE) were evaluated at different values of brake mean effective pressure (BMEP) of the engine. CO and UBHC emissions in engine exhaust were measured with Netel Chromatograph analyzer. DNPH method [15] was employed for measuring aldehydes in the experimentation. The exhaust of the engine was bubbled through 2,4 dinitrophenyl hydrazine (2,4 DNPH) solution. The hydrazones formed were extracted into chloroform and were analyzed by employing high performance liquid chromatography (HPLC) to find the percentage concentration of formaldehyde and acetaldehyde in the exhaust of the engine.

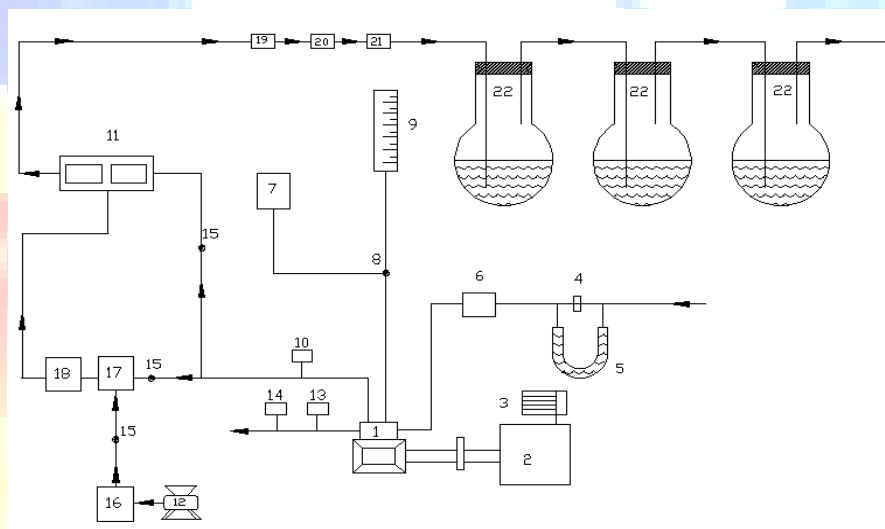

1. Engine, 2. Eddy current dynamometer, 3. Loading arrangement, 4. Orifice meter, 5. U-tube water monometer, 6. Air box, 7. Fuel tank, 8. Three-way valve, 9. Burette, 10. Exhaust gas temperature indicator, 11. CO analyzer, 12. Air compressor, 13. Outlet jacket water temperature indicator, 14. Outlet jacket water flow meter, 15. Directional valve, 16. Rotometer, 17. Air chamber and 18. Catalyst chamber 19. Filter, 20. Rotometer, 21. Heater, 22. Round bottom flasks containing DNPH solution

**Figure.1 Experimental set up**

A catalytic converter [9] (Figure .2) was fitted to exhaust pipe of engine. Provision was also made to inject a definite quantity of air into catalytic converter. Air quantity drawn from compressor

and injected into converter was kept constant so that backpressure does not increase. Experiments were carried out on CE and CCE with different test fuels under different operating conditions of catalytic converter like set-A, without catalytic converter and without air injection; set-B, with catalytic converter and without air injection; and set-C, with catalytic converter and with air injection. The accuracy of the instrumentation used in the experimentation is 0.1%.

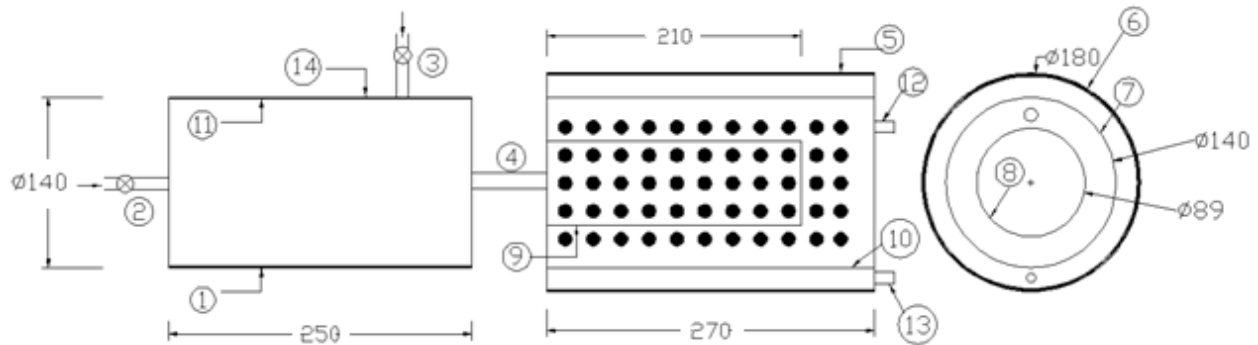

Note: All dimensions are in mm.

1. Air chamber, 2. Inlet for air chamber from the engine, 3. Inlet for air chamber from the compressor, 4. Outlet for air chamber, 5. Catalytic chamber, 6. Outer cylinder, 7. Intermediate-cylinder, 8. Inner-cylinder, 9. Inner sheet, 10. Intermediate sheet, 11. Outer sheet, 12. Outlet for exhaust gases, 13. Provision to deposit the catalyst, and, 14. Insulation.

Figure.2. Details of Catalytic converter

### 3. RESULTS AND DISCUSSION

#### 3.1 Performance Parameters

Figure 3 indicates that as compression ratio increased, peak BTE increased in both versions of the engine with test fuels at a speed of 3000 rpm. This was due to increase of expansion work. Gasses were expanded from higher value giving rise to work on the piston. At a compression ratio of 9:1 it was observed higher peak BTE with test fuels in both versions of the engine.

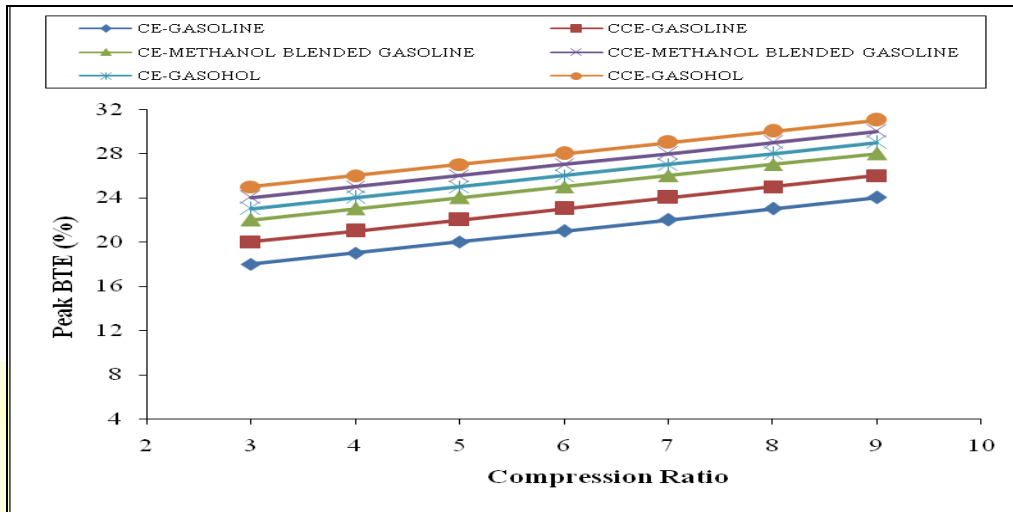

Figure 3. Variation of peak BTE with compression ratio in both versions of the engine with test fuels at a speed of 3000 rpm.

From Figure 4, it is observed that Peak BTE increased with an increase of speed of the engine at a compression ratio of 9:1. This was due to increase of turbulence of combustion. Catalytic activity was pronounced at higher speeds leading to produce higher BTE. At engine speed of 3000 rpm, higher peak BTE was observed with test fuels in both versions of the engine.

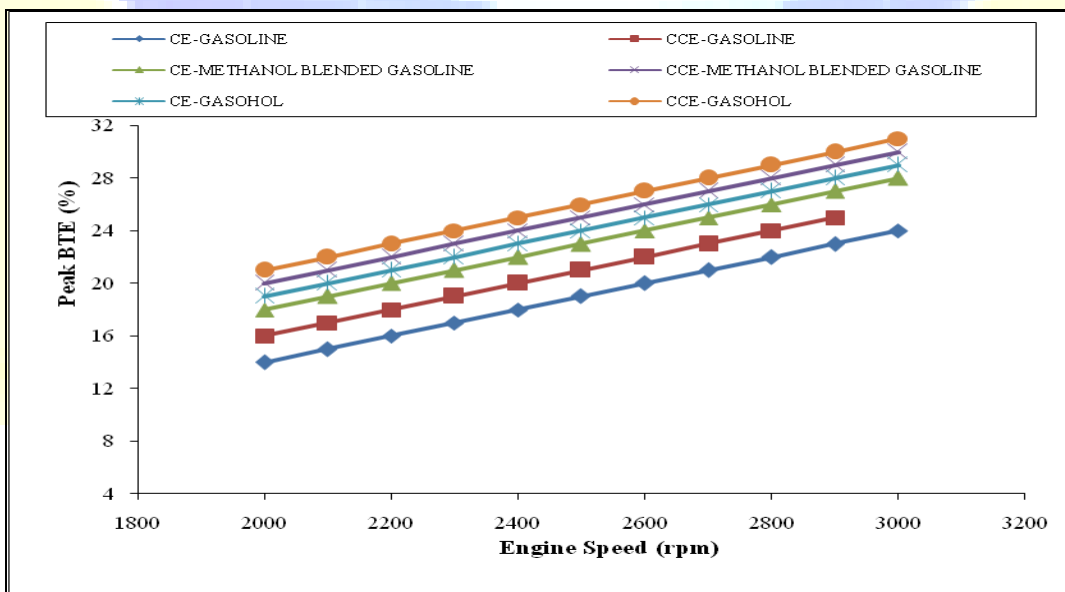

Figure 4. Variation of peak BTE with speed of the engine in both versions of the engine with test fuels at a compression ratio of 9:1.

Curves from Figure 5 indicate that BTE increased up to 80% of full load operation due to increase in fuel conversion efficiency and beyond that load it decreased due to increase of friction power with an increase of BMEP with test fuels at a compression ratio of 9:1 and speed of 3000 rpm with both versions of the engine. The reason for improving the efficiency with methanol blended gasoline at all loads over gasoline operation was because of improved homogeneity of the mixture with the presence of methanol, decreased dissociated losses, specific heat losses and cooling losses due to lower combustion temperatures. This was also due to high heat of evaporation of methanol, which caused the reduction the gas temperatures resulting in a lower ratio of specific heats leading to more efficient conversion of heat into work. Induction of methanol resulted in more moles of working gas, which caused high pressures in the cylinder. The observed increased in the ignition delay period would allow more time for fuel to vaporize before ignition started. This means higher burning rates resulted more heat release rate at constant volume, which was a more efficient conversion process of heat into work. The increase in efficiency with methanol blended gasoline was also due to lower stoichiometric air requirement of methanol blended gasoline over pure gasoline operation. Methanol has got high latent heat of vaporization allowing a denser fuel-air charge, excellent lean burn properties. Methanol is very flammable. The vapor pressure of methanol is higher than that of water, so the liquid methanol enters the gaseous phase faster than water. In the presence of oxygen in air, the methanol gas burns when ignited with a flame producing carbon dioxide and water. The intensity of reaction depends on the concentration of methanol gas. CCE showed higher thermal efficiency when compared to CE with both test fuels at loads, particularly at near full load operation, due to efficient combustion with catalytic activity, which was more pronounced at peak load, as catalytic activity increases with prevailing high temperatures at peak load. Peak BTE increased with increase of compression ratio with CE and CCE at different test fuels, due to increase in expansion work with increase of compression ratio.

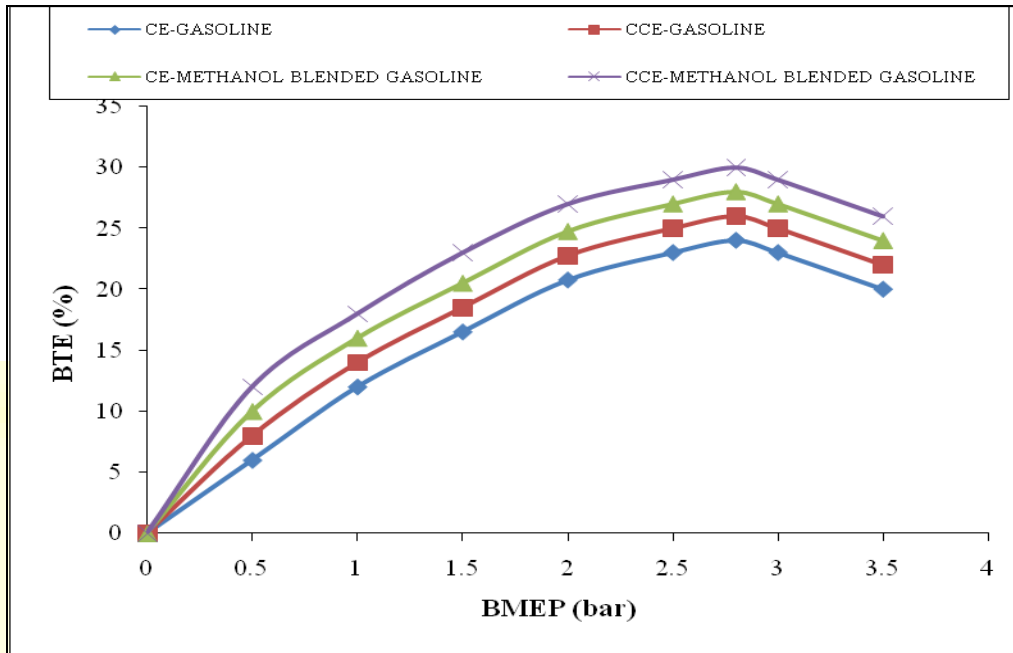

Figure 5. Variation of BTE with BMEP of the engine in both versions of the engine with pure gasoline and methanol blended gasoline at a speed of 3000 rpm and compression ratio of 9:1.

From Figure 6, it is noticed that CCE with gasohol gave higher peak BTE when compared with methanol blended gasoline in both versions of the engine. This was due to higher calorific value of ethanol in comparison with methanol giving rise to more energy supplied which was product of fuel burning rate and calorific value.

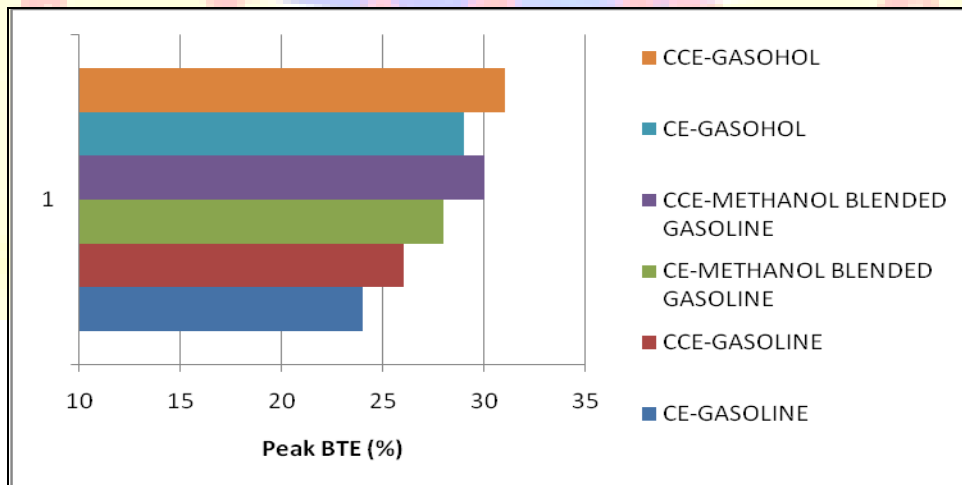
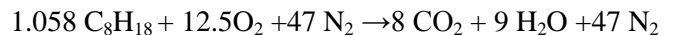

Figure 6. Bar charts showing the variation of peak BTE in both versions of the engine with test fuels at a speed of 3000 rpm and compression ratio of 9:1.



The ratio of moles of products to the reactants for gasoline and alcohols is as follows.

Reaction of gasoline



(60.5 moles)

(64.0 moles)

Reaction of ethanol

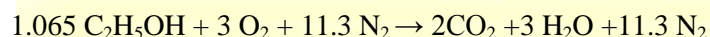

(15.3 moles)

(16.3 moles)

Reaction of methanol



(8.15 moles)

(8.65 moles)

Assuming all the fuel enter the engine completely evaporated, the fuel giving largest number of moles of product per mole of reactant should produce the greatest pressure in the cylinder after the combustion, all other factors being equal (which incidentally are not) The greater pressure taken alone would results in an increase in engine power. But an engine may not ingest its mixture with the fuel already evaporated. Under such conditions the number of moles of products should be examined on the basis of number of moles of air inducted since fuel occupies very little volume. Consider the fuel to enter the cylinder in liquid state points to a somewhat enhanced power output from ethanol on this rather simple basis as indicated from Table-1.

**Table 1: Comparative moles of products per moles of air at chemically correct mixture ratio neglecting dissociation**

Fuel	Dry basis			Wet basis	
	Ratio	Compared to gasoline	Ratio	Copmpared to gasoline	
Gasoline	1.058	1.000	1.075	1.000	
Ethanol	1.065	1.008	1.140	1.061	
Methanol	1.061	1.004	1.210	1.126	

From Figure 7, it is evident that exhaust gas temperature (EGT) increased with an increase of BMEP. EGT value was observed to be less with methanol blended gasoline in comparison with pure gasoline in both versions of the engine. This was due to higher value of latent heat of evaporation of methanol which absorbed heat from combustion. Pure gasoline operation on CE recorded higher value of EGT, while methanol blended gasoline operation on CCE gave lower value of EGT, as with methanol blended gasoline, work transfer from piston to gases in cylinder at the end of compression stroke was too large, leading to reduction in the magnitude of EGT.

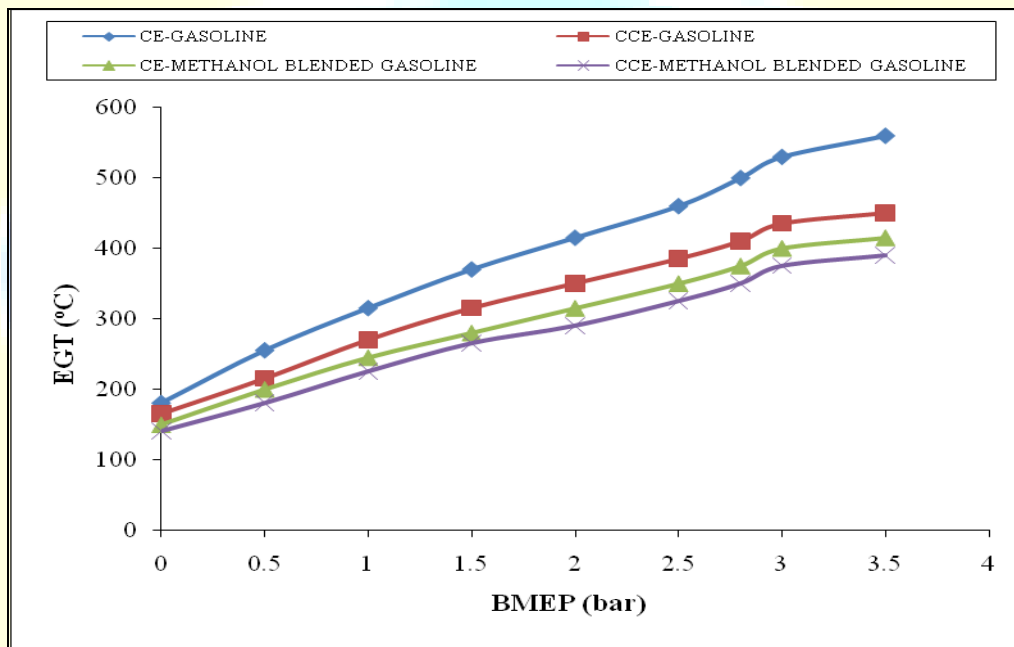

**Figure .7** Variation of EGT with BMEP of the engine in both versions of the engine with pure gasoline and methanol blended gasoline at a speed of 3000 rpm and compression ratio of 9:1.

From Figure 8, it is noticed that EGT was observed to be less with methanol blended gasoline in comparison with gasohol in both versions of the engine. This was due to higher value of latent heat of evaporation of methanol.

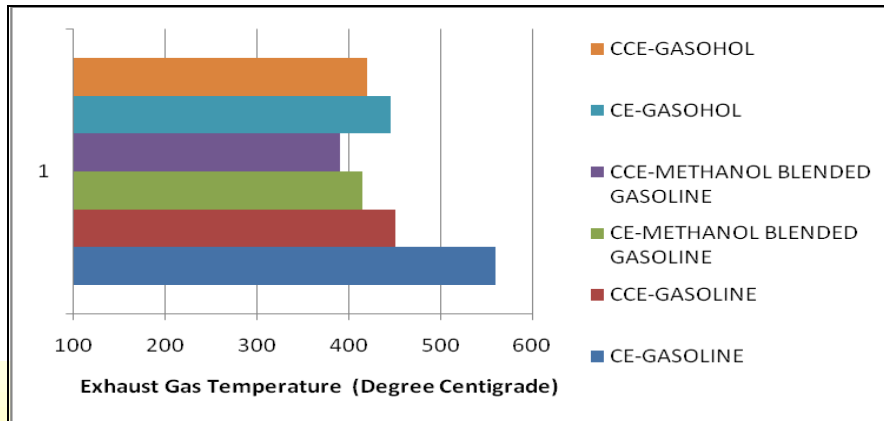

**Figure 8.** Bar charts showing the variation of EGT at peak load operation in both versions of the engine with test fuels at a speed of 3000 rpm and compression ratio of 9:1.

Figure 9 indicates that volumetric efficiency (VE) decreased with an increase of BMEP with test fuels in both versions of the engine. This was due to increase of gas temperatures with increase of BMEP. Methanol blended gasoline showed higher VE in comparison with gasoline operation in both configuration of the engine due to increase of mass and density of air with reduction of the temperature of air due to high latent heat of evaporation of methanol. CCE showed higher VE at all loads in comparison with CE with different test fuels, due to reduction of residual charge and deposits in the combustion chamber of CCE when compared to CE, which showed the similar trends as reported earlier [7].

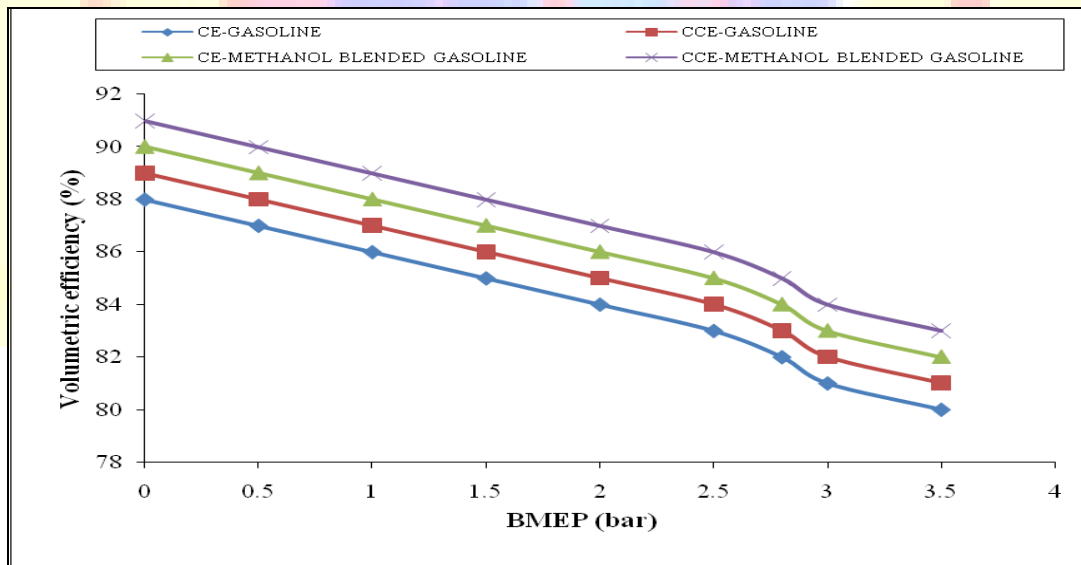

**Figure 9.** Variation of VE with BMEP of the engine in both versions of the engine with pure gasoline and methanol blended gasoline at a speed of 3000 rpm and compression ratio of 9:1.

From Figure 10, it is observed that methanol blended gasoline in CCE showed marginally higher VE in comparison with gasohol in the same configuration of the engine. This was due to as mentioned earlier higher value of latent heat of evaporation.

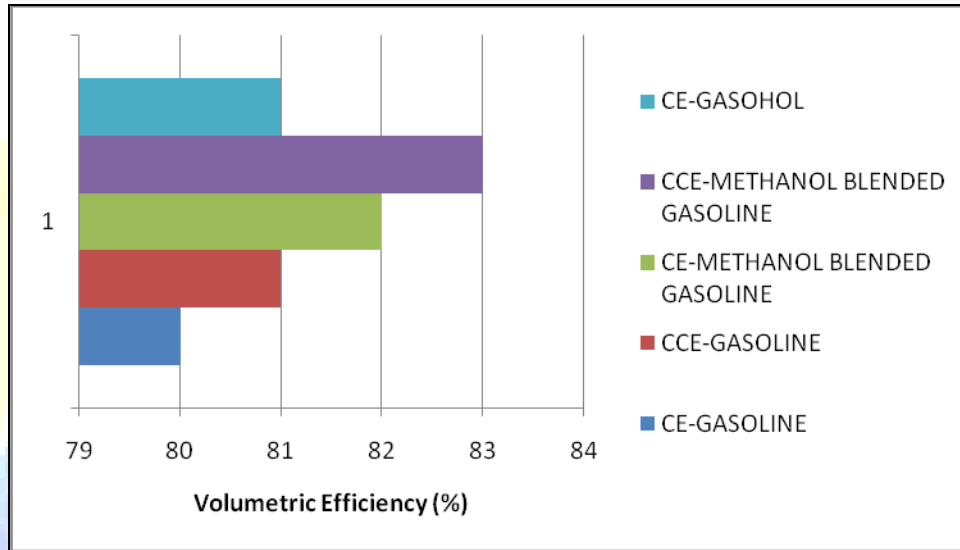

**Figure 10. Bar charts showing the variation of Volumetric efficiency at peak load operation in both versions of the engine with test fuels at a speed of 3000 rpm and compression ratio of 9:1.**

### 3.2 Exhaust Emissions

From Figure 11, it is noticed that as compression ratio decreases, CO emissions decreases in both versions of the engine with test fuels. This was due to increase of exhaust gas temperatures with decrease of compression ratios leading to oxidation of CO emissions in the exhaust pipe producing CO<sub>2</sub> emissions. Similar trends were reported [26] earlier.

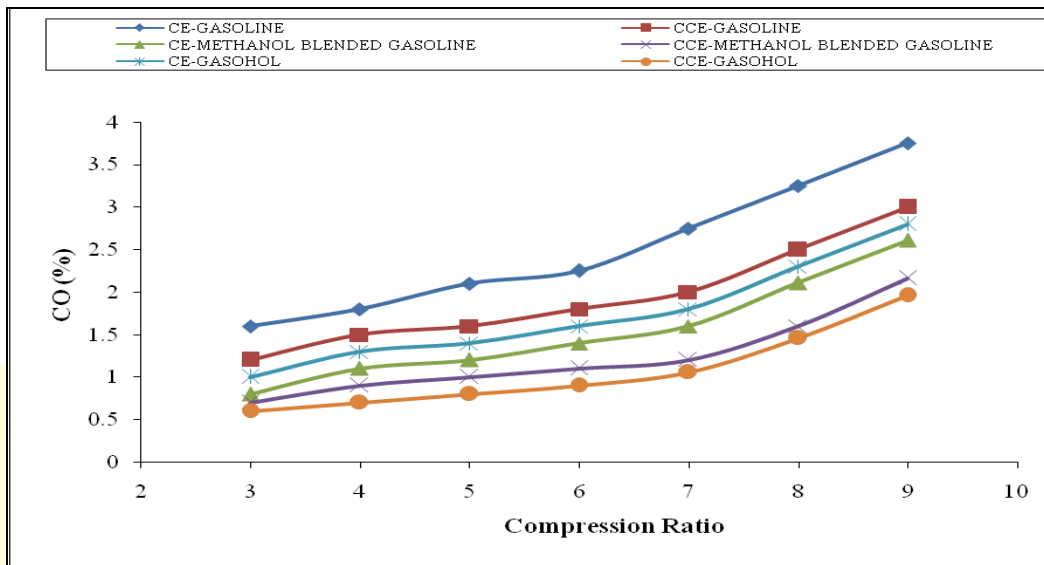

**Figure 11. Variation of CO emissions with compression ratio in both versions of the engine at a speed of 3000 rpm with test fuels.**

Curves from Figure 12 indicates that methanol blended gasoline decreased CO emissions at all loads when compared to pure gasoline operation on CCE and CE, as fuel-cracking reactions were eliminated with methanol. The combustion of alcohol produced more water vapor than free carbon atoms as methanol has lower C/H ratio of 0.25 against 0.44 of gasoline. Methanol has oxygen in its structure and hence its blends have lower stoichiometric air requirements compared to gasoline. Therefore more oxygen that was available for combustion with the blends of methanol and gasoline, lead to reduction of CO emissions. Methanol dissociated in the combustion chamber of the engine forming hydrogen, which helped the fuel-air mixture to burn quickly and thus increases combustion velocity, which brought about complete combustion of carbon present in the fuel to  $\text{CO}_2$  and also CO to  $\text{CO}_2$  thus made leaner mixture more combustible, causing reduction of CO emissions. CCE reduced CO emissions in comparison with CE. Copper or its alloys acted as catalyst in combustion chamber, whereby facilitated effective combustion of fuel leading to formation of  $\text{CO}_2$  instead of CO. Similar trends were observed with Reference-10 with pure gasoline operation on CCE.

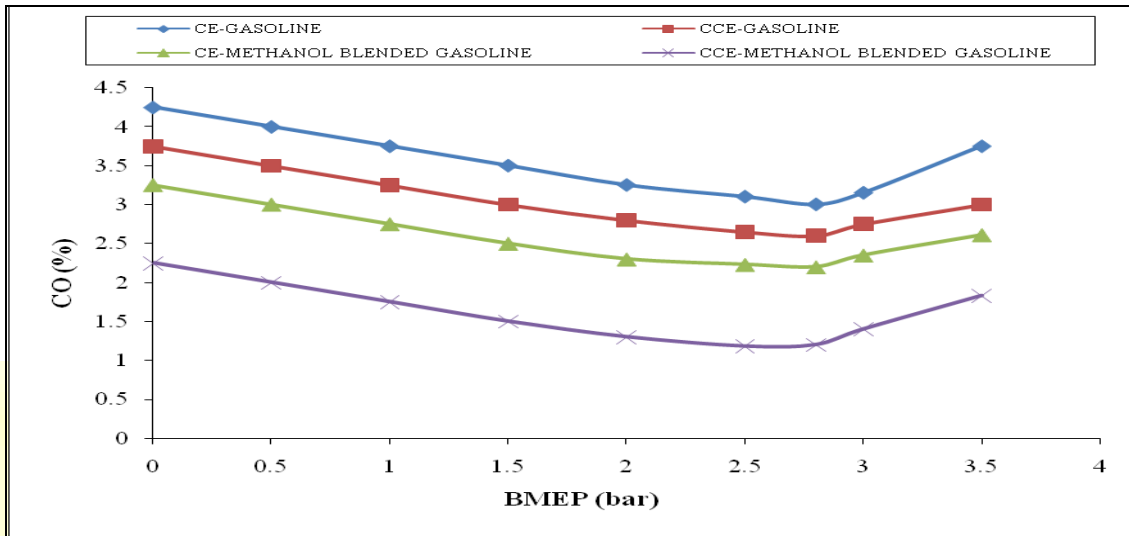

Figure 12. Variation of CO emissions with BMEP of the engine in both versions of the engine with pure gasoline and methanol blended gasoline at a speed of 3000 rpm and compression ratio of 9:1.

From Figure 13, it is noticed that CO emissions were observed to be marginally less with methanol blended gasoline in comparison with gasohol at peak load operation on both versions of the engine. This was due to lower value of C/H ratio of methanol in comparison with ethanol.

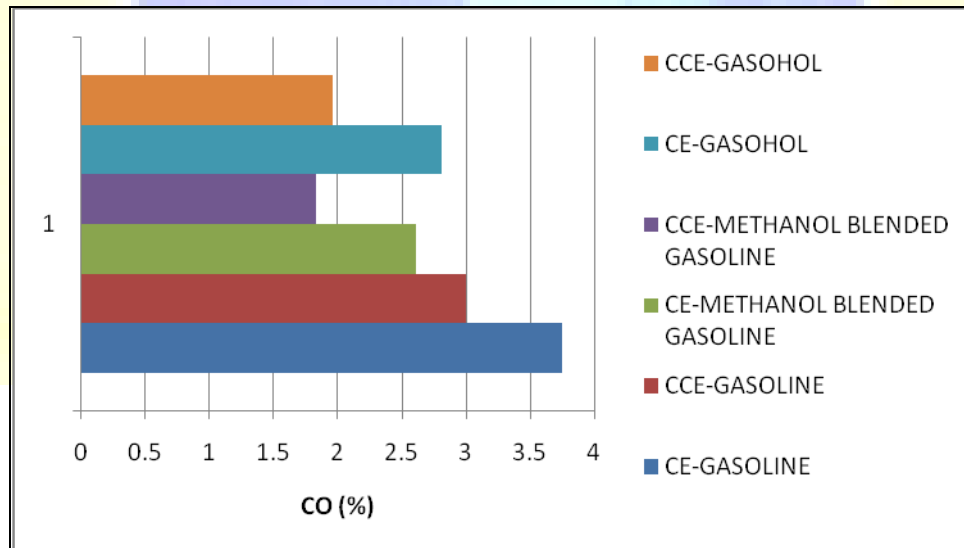
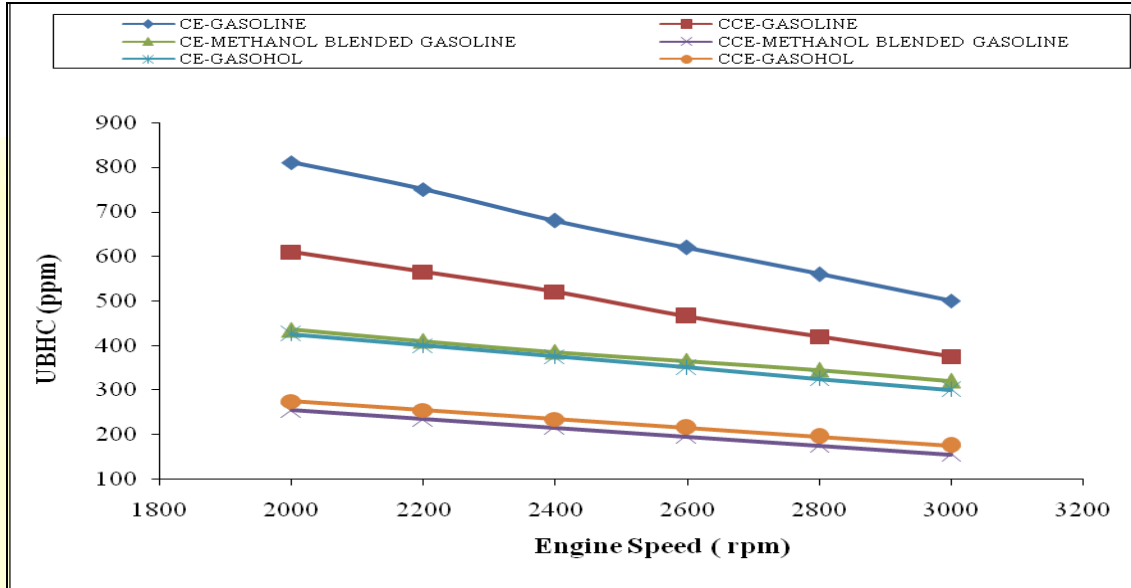

Figure 13. Bar charts showing the variation of CO emissions at peak load operation in both versions of the engine with test fuels at a speed of 3000 rpm and compression ratio of 9:1.

From Figure 14, it is observed that as speed increased, un-burnt hydro carbon emissions (UBHC) emissions decreased in both versions of the engine with test fuels. This was due to increase of turbulence causing efficient combustion leading to decrease UBHC emissions.



**Figure 14** Variation of UBHC emissions with speed of the engine in both versions of the engine with test fuels at a speed of 3000 rpm and compression ratio of 9:1.

Figure 15 indicates that UBHC emissions followed the same trend as CO emissions in CCE and CE with both test fuels, due to increase of flame speed with catalytic activity and reduction of quenching effect with CCE. Catalytic converter reduced pollutants considerably with CE and CCE and air injection into catalytic converter further reduced pollutants. In presence of catalyst, pollutants get further oxidised to give less harmful emissions like CO<sub>2</sub>.

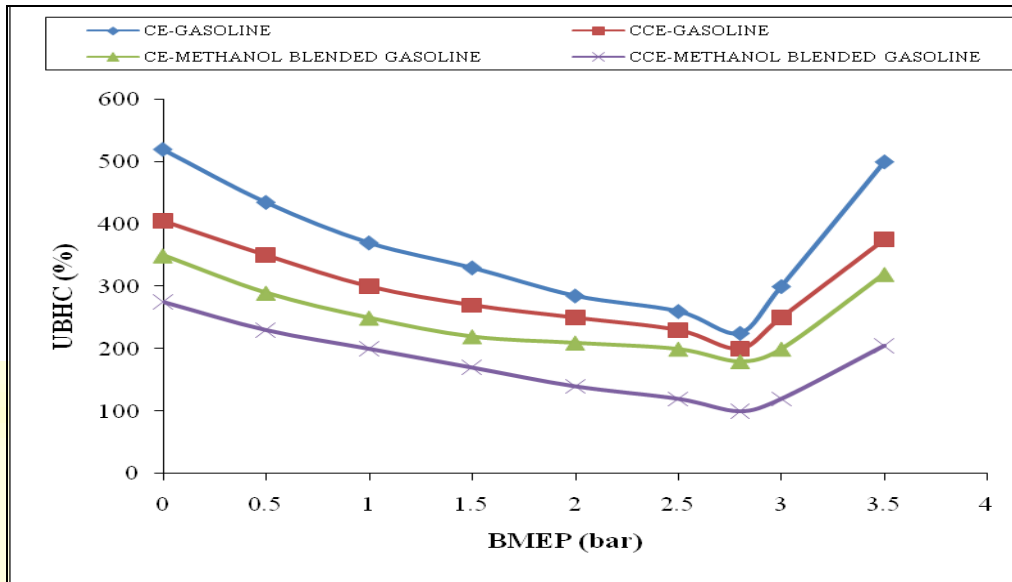

Figure 15. Variation of UBHC emissions with BMEP of the engine in both versions of the engine with pure gasoline and methanol blended gasoline at a speed of 3000 rpm and compression ratio of 9:1.

From Figure 16, it is noticed that UBHC emissions at peak load operation were observed to be less with methanol blended gasoline in comparison with gasohol at peak load operation on both versions of the engine. This was due to efficient combustion with methanol blended gasoline causing no accumulation of fuel in crevices of piston and combustion chamber walls.

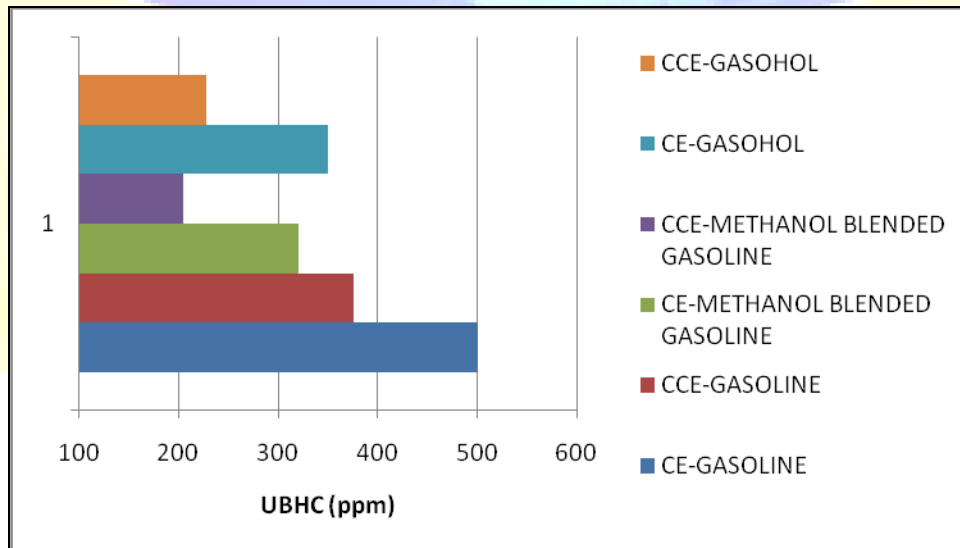

Figure 16. Bar charts showing the variation of UBHC emissions with BMEP of the engine in both versions of the engine with test fuels at a speed of 3000 rpm and compression ratio of 9:1.



### 3.3 Catalytic Converter

From Table-2, it is observed that CO emissions decreased considerably with Set-B operation, while Set-C further decreased emissions in both versions of the engine with test fuels. Efficient combustion with alcohol blended gasoline coupled with catalytic activity decreased CO emissions in CCE. From the same Table, it can be noticed that UBHC emissions decreased considerably with Set-B operation, while Set-C further decreased emissions in both versions of the engine with test fuels. Improved combustion with alcohol blended gasoline along with turbulence with catalytic activity decreased deposits in CCE causing decrease of UBHC emissions. From the Table, it can be noticed that formaldehyde emissions decreased considerably with Set-B operation, while Set-C further decreased emissions in both versions of the engine with test fuels. However, alcohol blended gasoline increased aldehyde emissions considerably in comparison with pure gasoline operation. But CCE decreased aldehyde emissions in comparison with CE with alcohol blended gasoline. This is due to improved combustion so that intermediate compounds will not be formed. Gasohol increased acetaldehyde emissions and methanol blended gasoline increased formaldehyde emissions. This is due to the nature of the fuel.

**Table 2: Data of Exhaust Emissions in four-stroke SI engine with different test fuels at different operating conditions of catalytic converter**

Emissions	Set	Pure Gasoline Operation				Gasohol Operation				Methanol blended gasoline			
		CE		CCE		CE		CCE		CE		CCE	
		S	M	S	M	S	M	S	M	S	M	S	M
CO (%)	Set-A	3.75	3.75	3.0	3.0	2.81	2.81	1.9	1.9	2.6	2.6	1.8	1.8
	Set-B	2.25	2.79	1.8	2.22	1.54	2.16	1.4	1.5	1.5	2.02	1.1	1.35
	Set-C	1.5	1.86	1.2	1.51	0.98	1.44	0.7	1.0	0.8	1.11	0.5	0.85
UBHC (ppm)	Set-A	500	500	375	375	350	350	228	228	320	320	205	225
	Set-B	300	360	206	265	165	270	130	197	135	195	105	165
	Set-C	200	240	105	145	122	180	80	131	90	130	65	105
Formaldehyde (% Concentration)	Set-A	6.5	6.5	4.5	4.5	12	12	9.0	9.0	10.	10	9.0	9.0
	Set-B	4.5	4.9	2.5	2.9	5.6	6.1	5.1	5.6	7.3	7.8	3.4	5.6
	Set-C	2.5	2.9	1.5	1.9	4.8	5.4	3.4	3.8	4.2	4.6	2.3	3.8
Acetaldehyde (% Concentration)	Set-A	5.5	5.5	3.5	3.5	10	10	6.6	6.6	14	14	9.1	9.1
	Set-B	3.5	4.0	2.5	2.7	4.7	5.2	3.4	3.9	9.3	9.8	5.9	6.4
	Set-C	1.5	1.9	1.0	0.95	3.7	4.1	2.3	2.7	4.0	4.5	2.5	3.1

S= Sponge iron, M= Manganese ore, Set-A= without catalytic converter and without air injection,  
Set- B= with catalytic converter and without air injection,  
Set- C= with catalytic converter and with air injection, CE= Conventional engine, CCE= Copper coated engine

#### 4. CONCLUSIONS

Peak BTE improved with gasohol operation while exhaust emissions decreased with methanol blended gasoline in both versions of the engine. Peak BTE was found to be higher at a compression ratio of 9:1 and at a speed of 3000 rpm for both versions of the engine with test fuels. Peak BTE increased by 25% with methanol blended gasoline operation with CCE in comparison with CE with pure gasoline operation. With CCE, Peak BTE increased by 3% with CCE with gasohol operation when compared with methanol blended gasoline operation. EGT decreased by 160-170°C with alcohol blended gasoline operation in comparison with pure gasoline operation with CCE. VE increased by 4% with methanol blended gasoline in comparison pure gasoline operation on CE. CO emissions increased marginally with increase of compression ratio and they were found to be lower at 80% of the peak load operation with test fuels and with different versions of the engine. CCE with methanol blended gasoline decreased CO and UBHC emissions nearly by 50% in comparison with pure gasoline operation on CE. CCE improved combustion and decreased exhaust emissions effectively in comparison with CE with test fuels. Set-B operation of the catalytic converter decreased the pollutants by 45%, while Set- C by 60%. Sponge iron was found to be more suitable in reducing exhaust emission in comparison with manganese ore.

#### ACKNOWLEDGEMENTS

Authors thank authorities of Chaitanya Bharathi Institute of Technology, Hyderabad for facilities provided. Financial assistance from Andhra Pradesh Council of Science and Technology (APCOST), Hyderabad, is greatly acknowledged.

**REFERENCES OF LITERATURE**

1. Fulekar, M. H. (1999). Chemical pollution – a threat to human life, Indian Journal of Environmental Technology, ISSN: 1064-3389,,1, 353-359.
2. Usha Madhuri, T., Srinivas, T. and Ramakrishna, K. (2003). A study on automobile exhaust pollution with regard to carbon monoxide emissions, Nature, Environment and Pollution Technology, ISSN: 0972-6268, 2, 473-474.
3. Environmental Pollution Analysis, edited by Khopkar, S.M. 2004. [New Age International (P) Ltd, Publishers, New Delhi], 180-190.
4. Sastry, M S., Suneela, M., Kumar, N. P. S. and Hussain, S. K. (2004). Air quality status at selected locations in Hyderabad city, Journal of Environmental Science and Engineering, ISSN: 0367-827X, 46, 86-91.
5. Ghose, M. K., Paul, R. and Benerjee, S. K. (2004). Assessment of the impact of vehicle pollution on urban air quality, Journal of Environmental Science and Engineering, ISSN: 0367-827X, 46, 33-40.
6. Engineering Chemistry, edited by Sharma, B.K. (2005). [Pragathi Prakashan (P) Ltd, Meerut], 150-160.
7. Nedunchezian, N. and Dhandapani, S. (2000). Experimental investigation of cyclic variation of combustion parameters in a catalytically activated two-stroke SI engine combustion chamber. Engineering Today, ISSN:0974-8377, 2, 11-18.
8. Murthy, P.V.K, Murali Krishna, M.V.S., Narasimha Kumar, S., Kishor, K. and Giridhar Reddy, P. (2011).Performance of copper coated two stroke spark ignition engine with alternate fuels with catalytic converter. International Journal of Engineering & Techno-Science,ISSN:0976-9293,2(2),145-149
9. Murali Krishna, M.V.S., Kishor, K., Murthy, P.V.K., Gupta, A.V.S.S.K.S.and Narasimha Kumar, S. (2011).Comparative studies on performance evaluation of four stroke copper coated spark ignition engine with catalytic converter with alcohols. International Journal of Advances in Engineering Research, ISSN: 2231-5152, 2(6),1-11.
10. Narasimha Kumar, S., Murali Krishna, M.V.S., Murthy, P.V.K., Seshagiri Rao, V.V.R. and Reddy, D.N. (2011). Performance of copper coated two stroke spark ignition engine with gasohol with catalytic converter. International Journal on Mechanical & Automobile Engineering, ISSN: 0974-231X, 12(1),36-43

11. Murali Krishna, M.V.S., Kishor, K., Gupta, A.V.S.S.K.S., Murthy, P.V.K. and Narasimha Kumar, S. (2012). Performance of copper coated two stroke spark ignition engine with methanol blended gasoline with catalytic converter. International Journal of Renewable and Sustainable Energy (American Institute of Physics), ISSN:1941-7012, 4(1), 013102.1 - 013102.9.
12. Murali Krishna M. V. S., Vara Prasad, C. M. and Venkata Ramana Reddy, Ch. (2000). Studies on control of carbon monoxide emissions in spark ignition engine using catalytic converter. Ecology, Environment and Conservation, 6 377-380.
13. Murali Krishna, M.V.S., Kishor, K., Prasad, P.R.K. and Swathy, G.V.V. (2006). Parametric studies of pollutants from copper coated spark ignition engine with catalytic converter with gasoline blended methanol, Journal of Current Sciences, ISSN: 0972-6101, 9 (2), 529-534.
14. Narasimha Kumar, S., Murali Krishna, M.V.S., Krishna Murthy, P.V., Seshagiri Rao, V.V.R. and Reddy, D.N. (2010). Emissions from copper coated two-stroke spark ignition engine with gasohol with catalytic converter. International Journal of Mechanical Engineering, ISSN: 0974-5823,3(2), 163-167.
15. Narasimha Kumar, S., Kishor, K., Murali Krishna, M.V.S. and Murthy, P.V.K. (2011). Studies on exhaust emissions from copper coated gasohol run spark ignition engine with catalytic converter. International Scholarly Research Net Work (ISRN) in Mechanical Engineering (ME), ISSN: 2090-5122, 1-6.
16. Murali Krishna, M.V.S., Kishor, K., Murthy, P.V.K. and Gupta, A. V S. S. K .S. (2011). Emissions from copper coated two-stroke spark ignition engine with methanol blended gasoline with catalytic converter. International Journal of Applied Engineering Research, ISSN: 0973-4562, 6(21), 2507-2516.
17. Murali Krishna, M.V.S., Murthy, P.V.K., Narasimha Kumar, S. and Kishor, K. (2011). Control of exhaust emissions from copper coated gasohol run two spark ignition engine with catalytic converter. International Journal of Mechanical Engineering Research ISSN: 1927-0607, 1(1), 24-37.
18. Murali Krishna, M.V.S., Kishor, K., Murthy, P.V.K., Gupta, A.V.S.S.K.S. and Narasimha Kumar, S.(2012). Comparative studies on emissions from two stroke copper coated spark

- ignition engine with alcohols with catalytic converter. International Journal of Scientific & Technology Research, ISSN: 2277-8616,1(2),March, 85-90
19. Murali Krishna, M.V.S., Kishor, K., Murthy, P.V.K. and Gupta, A.V.S.S.K.S. (2012). Control of exhaust emissions from copper coated two stroke spark ignition engine with methanol blended gasoline with catalytic converter. International Journal of Engineering and Innovative Technology, ISSN: 2277-3754, 1(5),9-16
20. Al-Farayedhi, A. A., Al-Dawood, A. M. and Gandhidasan, P. (2004). Experimental investigation of spark ignition engine performance using oxygenated fuel. ASME Journal of Engineering for Gas Turbines and Power, ISSN: 0742-4795, 126, 178-191, 2004.
21. Abu-Zaid., Badran, O. and Yamin, J. (2004). Effect of methanol addition on the performance of spark ignition engines. Energy and Fuels, 18, 312- 315,
22. Nakata, K. (2006). The effect of ethanol fuel on a spark ignition engine, SAE Paper No.2006-01-3380.
23. Pearson, R.J. (2007). Alcohol based fuels in high performance engines, SAE Paper No - 2007-01-0056.
24. Bahattin Celik, M. (2008). Experimental determination of suitable ethanol–gasoline blend rate at high compression ratio for gasoline engine, Applied Thermal Engineering,28, 396–404.
25. Rodrigo, C. Costa. and José, R. Sodr  (2010). Hydrous ethanol vs. gasoline-ethanol blend: engine performance and emissions, Fuel, 89, 287–293.
26. Murali Krishna, M.V.S. and Kishor, K. (2008). Investigations on catalytic coated spark ignition engine with methanol blended gasoline with catalytic converter. Indian Journal (CSIR) of Scientific and Industrial Research, ISSN: 0022-4456, 67,543-548
27. Murali Krishna, M.V.S., Kishor, K., Murthy, P.V.S., Gupta, A.V.S.S.K.S. and Narasimha Kumar, S. (2010). Performance evaluation of copper coated four stroke spark ignition engine with gasohol with catalytic converter, International Journal of Engineering Studies, 2(4), 465-473.